

# RF/Microwave Signal Generators MG3690C

RF/Microwave Signal Generator,  
0.1 Hz to 70 GHz/500 GHz

## Introduction

The MG3690C is the "ideal microwave signal generator" because it offers unsurpassed frequency coverage, the lowest phase noise, leveled output power, spectral purity, switching speed, modulation performance, size, upgradeability, reliability, and service. Our signal generators are configurable for a broad range of applications from R&D to manufacturing and depot repair. Anritsu provides you a total solution including proven reliability and standard 3 year warranty plus pre-sale and post-sale support that is the best in the industry.



MG3697C Microwave Signal Generator

## Signal Generator

The specifications in the following pages describe the warranted performance of the instrument for  $25 \pm 10$  °C. "Typical" specifications describe expected, but not warranted performance based on sample testing. They do not guarantee the performance of any individual product. "Typical" specifications do not account for measurement uncertainty.

### Frequency Coverage

Model/Option No.	Frequency Coverage <sup>a</sup>	Output Type
MG3691C	2 GHz to 10 GHz	K(f)
MG3692C	2 GHz to 20 GHz	K(f)
MG3693C	2 GHz to 31.8 GHz	K(f)
MG3694C	2 GHz to 40 GHz	K(f)
MG3695C	2 GHz to 50 GHz	V(f)
MG3697C	2 GHz to 67 GHz <sup>b</sup>	V(f)
Option 4	8 MHz to 2.2 GHz <sup>c</sup>	Model No. Dependent
Option 5	8 MHz to 2 GHz <sup>c</sup>	Model No. Dependent
Option 22	0.1 Hz to 10 MHz	Model No. Dependent

a. For frequency coverage beyond 70 GHz, utilize millimeter-wave multiplier 2000-1694 series (see page 19).

b. Operational to 70 GHz

c. All specifications apply  $\geq 10$  MHz

Options 4 and 5	Frequency extension down to 8 MHz Two options are available to extend the 2 GHz low end frequency limit of the base models down to 8 MHz. Option 4 uses a digital down-converter (DDC) with successive divide-by-two circuitry. It offers the best phase noise performance of the two choices, at the expense of some analog performance < 500 MHz. In that range, analog sweep mode is not available, and pulse modulation performance is specified as typical. In addition, frequency and phase modulation mod index is scaled by the division ratio of each band of the DDC. Option 5 maintains all analog performance by using a heterodyne mixing down-converter, but does not improve phase noise performance.
Option 22	If frequency coverage down to 0.1 Hz is desired, Option 22 can be added with either Option 4 or 5. Option 22 uses Direct Digital Synthesis (DDS) for CW and Step Sweep modes of operation. Modulation and analog sweep are not available in the DDS band. Frequency resolution < 10 MHz is 0.02 Hz. Output power across the complete instrument frequency range is degraded by 2 dB.

### CW Mode

Accuracy	Same as internal or external 10 MHz time base
Internal Time Base Stability	With aging: $< 2 \times 10^{-9}$ /day ( $< 5 \times 10^{-10}$ /day with Option 16) With temperature: $< 2 \times 10^{-8}$ /°C over 0 °C to 55 °C ( $< 2 \times 10^{-10}$ /°C with Option 16)
Resolution	0.01 Hz
Internal Time Base Calibration	The internal time base can be calibrated via the System Cal menu to match an external reference (10 MHz $\pm$ 50 Hz).
External 10 MHz Reference Input	Accepts external 10 MHz $\pm$ 50 Hz (typical) 0 dBm to +20 dBm time base signal Automatically disconnects the internal high-stability time-base option (if installed) Rear panel BNC (50 $\Omega$ impedance) Selectable bandwidth for best phase noise immunity or best phase tracking performance
10 MHz Reference Output	1 V <sub>p-p</sub> into 50 $\Omega$ , AC coupled Rear panel BNC (50 $\Omega$ impedance)
Phase Offset	Adjustable in 0.1 degree steps
Electronic Frequency Control (EFC) Input	-4 V to +4 V input range $8 \times 10^{-8}$ Hz/V sensitivity (typical) $\leq 250$ Hz modulation bandwidth Rear panel BNC (high impedance)

### Phase-Locked Step Sweep Mode

Sweep Width	Independently selected, 0.01 Hz to full range Every frequency step in sweep range is phase-locked.
Accuracy	Same as internal or external 10 MHz time base
Resolution (Minimum Step Size)	0.01 Hz
Linear/Log Sweep	User-selectable linear or log sweep In log sweep, step size logarithmically increases with frequency.
Steps	User-selectable number of steps or the step size
Number of Steps	Variable from 1 to 10,000
Step Size	0.01 Hz to the full frequency range of the instrument If the step size does not divide into the selected frequency range, the last step is truncated.
Dwell Time Per Step	Variable from 1 ms to 99 seconds
Fixed Rate Sweep	Variable from 20 ms to 99 seconds Allows the user to set the total time of the sweep, including lock time.

<b>Analog Sweep Mode (Option 6)</b>		
Sweep Width	Independently selected from 1 MHz to full frequency range For units with Option 4 (Digital Down Converter), the start frequency during analog sweep is limited to $\geq 2.2$ GHz for stop frequencies $> 20$ GHz. For stop frequencies $\leq 20$ GHz, the start frequency is limited to $\geq 500$ MHz. A range error will be displayed if any of these analog sweep start/stop limits are exceeded. Analog sweep is not available $< 10$ MHz with Option 22.	
Accuracy	The lesser of $\pm 30$ MHz or $\pm 2$ MHz $+0.25\%$ of sweep width for Sweep Speeds of $\leq 50$ MHz/ms (typical)	
Sweep Time Range	30 ms to 99 seconds	
<b>Alternate Sweep Mode</b>		Sweeps alternately in step sweep between any two sweep ranges. Each sweep range may be associated with a power level.
<b>Manual Sweep Mode</b>		Provides stepped, phase-locked adjustment of frequency between sweep limits. User-selectable number of steps or step size.
<b>List Sweep Mode</b>		Under GPIB or Ethernet control, or via the front panel, up to 4 tables with 2000 non-sequential frequency/power sets can be stored and then addressed as a phase-locked step sweep. One table of 2000 points is stored in non-volatile memory. All other tables are stored in volatile memory.
<b>Programmable Frequency Agility</b>		Under GPIB or Ethernet control, up to 3202 non-sequential frequency/power sets can be stored and then addressed as a phase-locked step sweep. Data is stored in volatile memory.
<b>Markers</b>		Up to 20 independent, settable markers (F0 – F9 and M0 – M9)
Video Markers	+5 V or –5 V marker output, selectable from system menus AUX I/O connector, rear panel	
Intensity Markers	Produces an intensity dot on analog display traces, obtained by a momentary dwell in RF sweep, in analog sweeps of $< 1$ second.	
Marker Accuracy	Same as sweep frequency accuracy	
Marker Resolution:	Analog Sweep: 1 MHz or Sweep Width/4096, which ever is greater Step Sweep: 0.01 Hz	
<b>Sweep Triggering</b>		Sweep triggering is provided for Analog Frequency Sweep, Step Frequency Sweep, List Frequency Sweep, and CW Power Sweep.
Auto	Triggers sweep automatically	
External	Triggers a sweep on the low to high transition of an external TTL signal. AUX I/O connector, rear panel	
Single	Triggers, aborts, and resets a single sweep Reset sweep may be selected to be at the top or bottom of the sweep.	
<b>General</b>		
Stored Setups	Stores front panel settings and nine additional front-panel setups in a non-volatile RAM. A system menu allows saving and recalling of instrument setups. Whenever the instrument is turned on, control settings come on at the same functions and values existing when the instrument was turned off.	
Memory Sequencing Input	Accepts a TTL low-level signal to sequence through ten stored setups. AUX I/O connector, rear panel	
Self-Test	Instrument self-test is performed when Self-Test soft-key is selected. If an error is detected, an error message is displayed in a window on the LCD identifying the probable cause and remedy.	
Secure Mode	Disables all frequency and power level state displays. Stored setups saved in secure mode remain secured when recalled. Mode selectable from a system menu and via GPIB or Ethernet.	
Parameter Entry	Instrument-controlled parameters can be entered in multiple ways: keypad, rotary data knob, or the touch pads of the cursor-control key. Controlled parameters are frequency, power level, sweep time, dwell time, and number of steps. Keypad entries are terminated by pressing the appropriate soft key. Edits are terminated by exiting the edit menu.	
Reset	Returns all instrument parameters to predefined default states or values. Any pending GPIB or Ethernet I/O is aborted. Selectable from the system menu	
Master/Slave Operation	Allows two output signals to be swept with a user-selected frequency offset. One instrument controls the other via AUX I/O and SERIAL I/O connections. Requires a Master/Slave Interface Cable Set (part number ND36329).	
User Level Flatness Correction	Allows user to calibrate out path loss due to external switching and cables via entered power table from a GPIB power meter or calculated data. When user level correction is activated, entered power levels are delivered at the point where calibration was performed. Supported power meters are Anritsu ML2437A, ML2438A, ML2480A/B, ML2490A, and ML4803A and HP 437B, 438A, and 70100A. Five user tables are available with up to 801 points/table.	
Warm Up Time:	From Standby: 30 minutes From Cold Start (0 °C): 120 hours to achieve specified frequency stability with aging Instruments disconnected from AC line power for more than 72 hours require 30 days to return to specified frequency stability with aging.	
Power	85 VAC to 264 VAC, 48 Hz to 440 Hz, 250 VA maximum	
Standby	With AC line power connected, unit is placed in standby when front panel power switch is released from the OPERATE position.	
Weight	18 kg maximum	
Dimensions	133 mm H x 429 mm W x 450 mm D	
Warranty	3 years from ship date	

<b>Remote Operation</b>	All instrument functions, settings, and operating modes (except for power on/standby) are controllable using commands sent from an external computer via Ethernet (VXI-11 over TCP/IP) or GPIB (IEEE-488 interface bus). Note: For users who wish to use a USB control interface, the following adapter available from National Instruments is recommended: USB: NI GPIB-USB-MS
Ethernet Port	10/100 Base-T
Ethernet Address	DHCP with Auto-IP 169.254.90.55 (default) or static 192.168.0.254
GPIB Address	Selectable from a system menu
GPIB Commands	Native, SCPI
IEEE -488 Interface Function Subset	Source Handshake: SH1 Acceptor Handshake: AH1 Talker: T6 Listener: L4 Service Request: SR1 Remote/Local: RL1 Parallel Poll: PP1 Device Clear: DC1 Device Trigger: DT1 Controller Capability: C0, C1, C2, C3, C28 Tri-State Driver: E2
GPIB Status Annunciators	When the instrument is operating in Remote, the GPIB status annunciators (listed below) will appear in a window on the front panel LCD.
Remote	Operating on the GPIB or via Ethernet, all instrument front panel keys are ignored, except for the SYSTEM key and the RETURN TO LOCAL soft key.
LLO (Local Lockout)	Disables the RETURN TO LOCAL soft key. Instrument can be placed in local mode only via Ethernet or GPIB, or by cycling line power.
Emulations	The instrument responds to the published GPIB commands and responses of the Anritsu Models 6600, 6700, and 6XX00-series signal sources. When emulating another signal source, the instrument will be limited to the capabilities, mnemonics, and parameter resolutions of the emulated instrument.

---

**Environmental (MIL-PRF-28800F, class 3)**

Storage Temperature Range	-40 °C to +75 °C
Operating Temperature Range	0 °C to +50 °C
Relative Humidity	5 % to 95 % at 40 °C (non-condensing)
Altitude	4,600 meters, 43.9 cm Hg
EMI	Meets the emission and immunity requirements of EN61326: 1998 EN55011: 1991/CISPR-11:1990 Group 1 Class A EN61000-4-2: 1995 - 4 kV CD, 8 kV AD EN61000-4-3: 1997 - 3 V/m EN61000-4-4: 1995 - 0.5 kV SL, 1 kV PL EN61000-4-5: 1995 - 1 kV - 2 kV L-E EN61000-4-6: 1996 EN61000-4-11: 1994
Vibration:	Random, 5 Hz to 500 Hz, 0.015 to 0.0039 g <sup>2</sup> /Hz PSD; Sinusoidal, 5 Hz to 55 Hz, 0.33 mm displacement
Safety Directive:	EN 61010-1: 1993 + A1: 92 + A2: 95

**Definitions**

Free Running Mode Step or List Sweep  
 $t_{sw}$  = Switching Time, Unlocked

Lock Status Indicator Rear Panel AUX I/O connector (pin 11)  
 The lock status indicator goes high when the output is within 1 kHz of the final frequency.  
 $t_{lk}$  = Locked Time = 1 ms +  $t_{dw}$   
 $t_{dw}$  = Dwell Time, after locking. Selectable, 1 ms minimum  
 $t_{lk}(\text{min}) = 2 \text{ ms}$

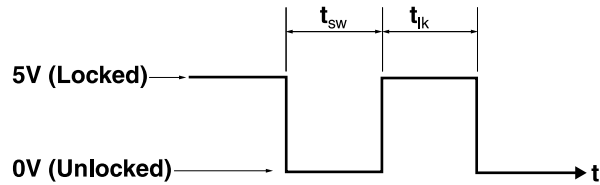

Single Frequency Trigger Mode (List, non-sequential, and CFx modes)  
 $t_r$  = Trigger Response Time = 2 ms  
 (Applies to GPIB, Ethernet and External TTL triggers)

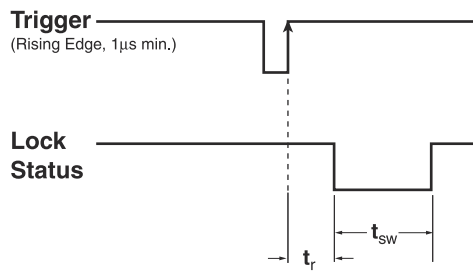

**Switching Time ( $t_{sw}$ )**

$t_{sw}^a$ (ms)	Condition
5 ms + 1 ms/GHz	Step not starting at, or crossing dwell frequencies
7 ms + 1 ms/GHz (typical)	Step not starting at, or crossing band switching frequencies
8 ms + 1 ms/GHz (typical)	Step starting at, or crossing band switching frequencies

a. Not applicable with FM mode active.

Band Switching Dwell Frequencies 2 (2.2 with Option 4), 10, 20, 40 GHz  
 Filter Switching Dwell Frequencies 3.3, 5.5, 8.4, 13.25, 25, 32 GHz  
 < 2.2 GHz w/Option 4 12.5, 15.625, 22.5, 31.25, 43.75, 62.5, 87.5, 125, 175, 250, 350, 500, 700, 1050, 1500 MHz

**Spectral Purity**

All specifications apply at the lesser of +10 dBm output or maximum specified leveled output power unless otherwise noted.

**Spurious Signals**

Harmonic and Harmonic-Related

Frequency Range	Standard
0.1 Hz to 10 MHz (Option 22)	< -30 dBc
10 MHz to ≤ 100 MHz (Option 4)	< -40 dBc
> 100 MHz to ≤ 2.2 GHz (Option 4)	< -50 dBc
10 MHz to ≤ 50 MHz (Option 5)	< -30 dBc
> 50 MHz to < 2 GHz (Option 5)	< -40 dBc
2 GHz (> 2.2 GHz w/Option 4) to ≤ 20 GHz	< -60 dBc <sup>a</sup>
> 20 GHz to ≤ 40 GHz	< -40 dBc <sup>a,b</sup>
> 40 GHz to ≤ 50 GHz (MG3695C)	< -40 dBc <sup>a</sup>
> 40 GHz to ≤ 67 GHz (MG3697C)	< -25 dBc

a. -30 dBc typical with high power Option 15.

b. 20 GHz to 21 GHz, and 39 GHz to 40 GHz, -20 dBc typical (Option 15 only).

Non-Harmonic

Frequency Range	Standard
0.1 Hz to 10 MHz (Option 22)	< -30 dBc
10 MHz to ≤ 2.2 GHz (Option 4)	< -60 dBc
10 MHz to ≤ 2 GHz (Option 5)	< -40 dBc
> 2 GHz (2.2 GHz w/Option 4) to ≤ 67 GHz	< -60 dBc

Power Line and Fan Rotation Spurious Emissions (dBc)

Frequency	Offset from Carrier		
	300 Hz	300 Hz to 1 kHz	> 1 kHz
10 MHz to ≤ 500 MHz (Option 4)	< -68	< -72	< -72
> 500 MHz to ≤ 1050 MHz (Option 4)	< -62	< -72	< -72
> 1050 MHz to ≤ 2200 MHz (Option 4)	< -56	< -66	< -66
0.01 GHz to ≤ 8.4 GHz	< -50	< -60	< -60
> 8.4 GHz to ≤ 20 GHz	< -46	< -56	< -60
> 20 GHz to ≤ 40 GHz	< -40	< -50	< -54
> 40 GHz to ≤ 67 GHz	< -34	< -44	< -48

Residual FM CW and Step Sweep modes, 50 Hz to 15 kHz BW (typical)  
Note: Residual FM is not applicable with FM locked mode

Frequency Range	Residual FM (Hz RMS)	
	Option 3/3X/3XA	Standard
≤ 8.4 GHz	< 40	< 120
> 8.4 GHz to 20 GHz	< 40	< 220
> 20 GHz to ≤ 40 GHz	< 80	< 440
> 40 GHz to ≤ 67 GHz	< 160	< 880

Residual FM Analog Sweep and Unlocked FM modes, 50 Hz to 15 kHz BW (typical)  
Note: Residual FM is not applicable with FM locked mode

Frequency Range	Residual FM (kHz RMS)	
	Unlocked Narrow FM mode	Unlocked Wide FM mode or Analog Sweep (typical)
0.01 GHz to ≤ 20 GHz	< 10	< 25
> 20 GHz to ≤ 40 GHz	< 20	< 50
> 40 GHz to ≤ 67 GHz	< 40	< 100

AM Noise Floor Typically < -145 dBm/Hz at 0 dBm output and offsets > 5 MHz from carrier

Single-Sideband Phase Noise

Phase noise is specified and guaranteed only with internal reference. In External Reference mode, the phase noise of the external supplied reference, and the selected external reference bandwidth, will dictate the instrument phase noise performance. Phase noise is not degraded when adding high power Option 15.

Single-Sideband Phase Noise (dBc/Hz): (Typical)

Frequency Range	10 Hz	100 Hz	1 kHz	10 kHz	100 kHz	1 MHz
0.1 Hz to <10 MHz (Option 22)	-80 (-100)	-90 (-110)	-120 (-125)	-130 (-139)	-130 (-141)	-130 (-141)
10 MHz to 15.625 MHz (Option 4)	-102 (-113)	-128 (-133)	-142 (-149)	-145 (-152)	-145 (-153)	-145 (-153)
> 15.625 MHz to 31.25 MHz (Option 4)	-97 (-109)	-125 (-130)	-142 (-147)	-144 (-149)	-144 (-153)	-145 (-155)
> 31.25 MHz to 62.5 MHz (Option 4)	-92 (-104)	-122 (-128)	-140 (-146)	-142 (-146)	-143 (-150)	-145 (-155)
> 62.5 MHz to 125 MHz (Option 4)	-87 (-98)	-114 (-118)	-133 (-139)	-130 (-140)	-130 (-143)	-145 (-155)
> 125 MHz to 250 MHz (Option 4)	-82 (-93)	-108 (-113)	-126 (-134)	-124 (-134)	-124 (-138)	-145 (-153)
> 250 MHz to 500 MHz (Option 4)	-75 (-87)	-102 (-109)	-120 (-128)	-118 (-127)	-118 (-130)	-143 (-149)
> 500 MHz to 1050 MHz (Option 4)	-70 (-80)	-94 (-100)	-115 (-123)	-115 (-122)	-116 (-126)	-138 (-144)
> 1050 MHz to 2200 MHz (Option 4)	-65 (-74)	-86 (-96)	-113 (-117)	-111 (-116)	-114 (-120)	-133 (-139)
10 MHz to < 2000 MHz (Option 5)	-62 (-72)	-85 (-95)	-100 (-104)	-102 (-106)	-102 (-106)	-111 (-114)
2 GHz to 6 GHz	-54 (-64)	-81 (-88)	-102 (-109)	-103 (-110)	-106 (-114)	-128 (-133)
> 6 GHz to 10 GHz	-52 (-62)	-75 (-85)	-98 (-106)	-104 (-109)	-106 (-113)	-126 (-132)
> 10 GHz to 20 GHz	-45 (-55)	-69 (-78)	-92 (-101)	-98 (-103)	-98 (-106)	-124 (-131)
> 20 GHz to 40 GHz	-38 (-48)	-62 (-72)	-86 (-94)	-92 (-100)	-92 (-100)	-118 (-124)
> 40 GHz to 67 GHz	-32 (-42)	-56 (-66)	-80 (-88)	-87 (-94)	-82 (-91)	-112 (-118)

Single-Sideband Phase Noise (dBc/Hz) – Option 3: (Typical)

Frequency Range	10 Hz	100 Hz	1 kHz <sup>a</sup>	10 kHz <sup>a</sup>	100 kHz	1 MHz
0.1 Hz to < 10 MHz (Option 22)	-80 (-100)	-90 (-110)	-120 (-125)	-130 (-139)	-130 (-141)	-130 (-141)
10 MHz to 15.625 MHz (Option 4)	-102 (-120)	-128 (-140)	-142 (-150)	-145 (-152)	-148 (-153)	-148 (-152)
> 15.625 MHz to 31.25 MHz (Option 4)	-97 (-108)	-125 (-128)	-142 (-149)	-145 (-153)	-148 (-153)	-148 (-155)
> 31.25 MHz to 62.5 MHz (Option 4)	-92 (-109)	-122 (-131)	-140 (-146)	-145 (-153)	-148 (-153)	-148 (-156)
> 62.5 MHz to 125 MHz (Option 4)	-87 (-98)	-114 (-118)	-134 (-139)	-142 (-147)	-143 (-148)	-148 (-155)
> 125 MHz to 250 MHz (Option 4)	-82 (-93)	-108 (-113)	-129 (-134)	-138 (-143)	-137 (-142)	-148 (-153)
> 250 MHz to 500 MHz (Option 4)	-77 (-91)	-102 (-114)	-124 (-130)	-132 (-137)	-128 (-137)	-144 (-153)
> 500 MHz to 1050 MHz (Option 4)	-72 (-83)	-98 (-103)	-119 (-123)	-126 (-132)	-122 (-132)	-139 (-150)
> 1050 MHz to 2200 MHz (Option 4)	-66 (-77)	-92 (-101)	-113 (-119)	-121 (-126)	-117 (-125)	-135 (-146)
10 MHz to < 2000 MHz (Option 5)	-64 (-72)	-85 (-95)	-100 (-104)	-102 (-106)	-102 (-106)	-111 (-114)
2 GHz to 6 GHz	-54 (-77)	-82 (-93)	-106 (-111)	-115 (-119)	-112 (-119)	-136 (-140)
> 6 GHz to 10 GHz	-52 (-73)	-75 (-88)	-102 (-109)	-113 (-119)	-115 (-120)	-134 (-140)
> 10 GHz to 20 GHz	-52 (-66)	-69 (-82)	-100 (-105)	-109 (-115)	-109 (-115)	-130 (-137)
> 20 GHz to 40 GHz	-45 (-59)	-63 (-75)	-94 (-98)	-104 (-108)	-103 (-109)	-122 (-131)
> 40 GHz to 67 GHz	-40 (-51)	-58 (-68)	-89 (-91)	-97 (-103)	-97 (-103)	-118 (-125)

a. When fitted with Option 36 and when multiple units are connected for purposes of Ultra-Stable Phase Tracking, phase noise may be degraded by up to 4 dB at 1 kHz and 10 kHz offsets.

Single-Sideband Phase Noise (dBc/Hz) – Option 3X and 3XA: (Typical)

Frequency Range	Offset from Carrier						
	1 Hz	10 Hz	100 Hz	1 kHz <sup>a</sup>	10 kHz <sup>a</sup>	100 kHz	1 MHz
0.1 Hz to < 10 MHz (Option 22)	-60 (-70)	-80 (-100)	-90 (-110)	-120 (-125)	-130 (-139)	-130 (-141)	-130 (-141)
10 MHz to 15.625 MHz (Option 4)	-94 (-103)	-118 (-128)	-136 (-141)	-142 (-150)	-145 (-152)	-148 (-153)	-148 (-152)
> 15.625 MHz to 31.25 MHz (Option 4)	-88 (-96)	-113 (-123)	-130 (-137)	-142 (-149)	-145 (-153)	-148 (-153)	-148 (-155)
> 31.25 MHz to 62.5 MHz (Option 4)	-83 (-90)	-109 (-118)	-125 (-133)	-140 (-146)	-145 (-153)	-148 (-153)	-148 (-156)
> 62.5 MHz to 125 MHz (Option 4)	-77 (-86)	-103 (-111)	-119 (-127)	-134 (-139)	-142 (-147)	-143 (-148)	-148 (-155)
> 125 MHz to 250 MHz (Option 4)	-71 (-81)	-97 (-104)	-113 (-121)	-129 (-134)	-138 (-143)	-137 (-142)	-148 (-153)
> 250 MHz to 500 MHz (Option 4)	-67 (-76)	-91 (-98)	-107 (-115)	-124 (-130)	-132 (-137)	-128 (-137)	-144 (-153)
> 500 MHz to 1050 MHz (Option 4)	-60 (-69)	-84 (-92)	-101 (-109)	-119 (-123)	-126 (-132)	-122 (-132)	-139 (-150)
> 1050 MHz to 2200 MHz (Option 4)	-53 (-62)	-77 (-87)	-95 (-103)	-113 (-119)	-121 (-126)	-117 (-125)	-135 (-146)
10 MHz to < 2000 MHz (Option 5)	-38 (-45)	-68 (-78)	-85 (-95)	-100 (-104)	-102 (-106)	-102 (-106)	-111 (-114)
2 GHz to 6 GHz	-46 (-52)	-70 (-77)	-86 (-94)	-106 (-111)	-115 (-119)	-112 (-119)	-136 (-140)
> 6 GHz to 10 GHz	-38 (-46)	-68 (-77)	-83 (-91)	-102 (-109)	-113 (-119)	-115 (-120)	-134 (-140)
<b>Note:</b> Option 3XA is limited to the specifications above. Option 3X also includes the specifications below.							
> 10 GHz to 20 GHz	-35 (-42)	-64 (-72)	-80 (-85)	-100 (-105)	-109 (-115)	-109 (-115)	-130 (-137)
> 20 GHz to 40 GHz	-29 (-36)	-58 (-65)	-74 (-79)	-94 (-98)	-104 (-108)	-103 (-109)	-122 (-131)
> 40 GHz to 67 GHz	-23 (-30)	-53 (-59)	-69 (-73)	-89 (-91)	-97 (-103)	-97 (-103)	-118 (-125)

a. When fitted with Option 36 and when multiple units are connected for purposes of Ultra-Stable Phase Tracking, phase noise may be degraded by up to 4 dB at 1 kHz and 10 kHz offsets.

Measured SSB Phase Noise

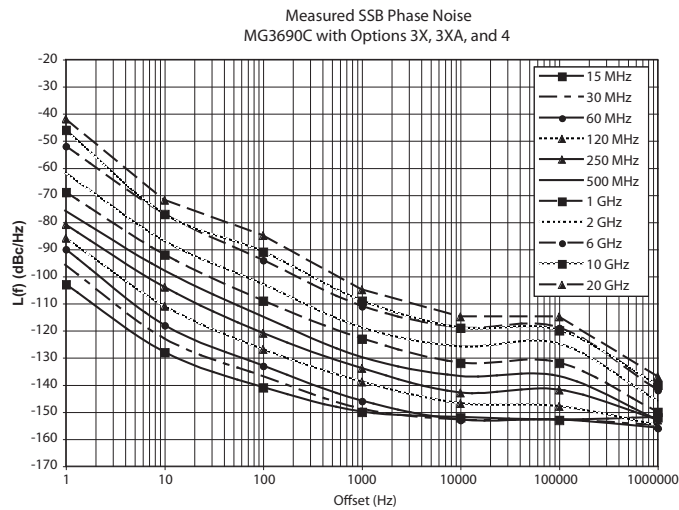
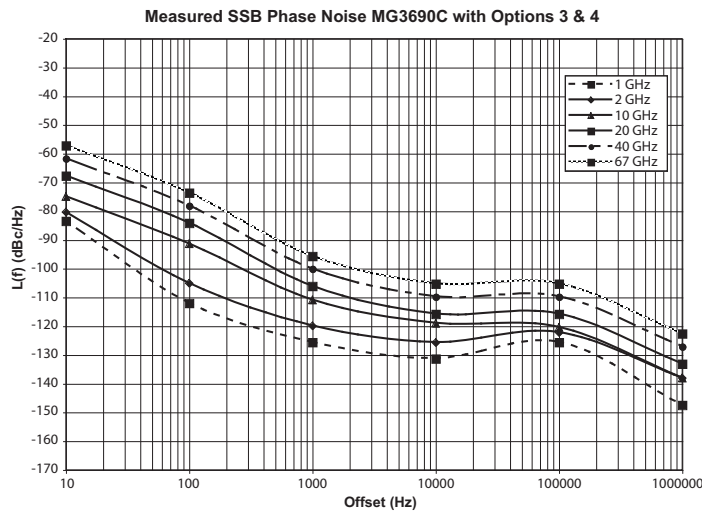
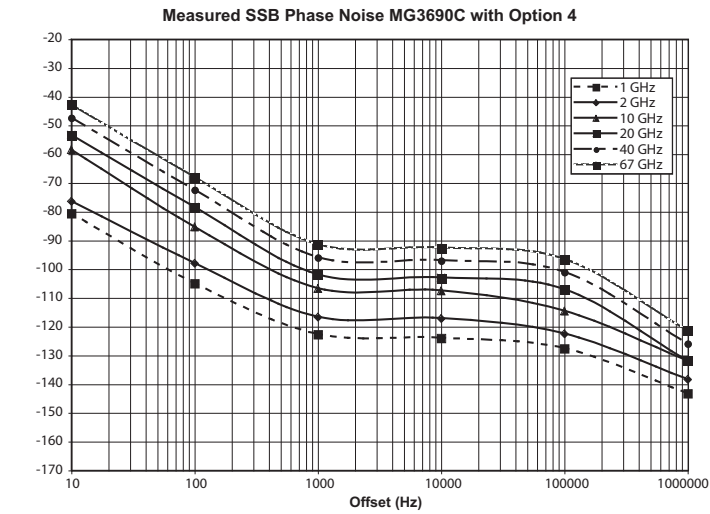



**RF Output**

Power level specifications apply at 25 ± 10 °C.

**Maximum Leveled Output Power** For output power with Option 22, 0.1 Hz to 10 MHz coverage, derate all specifications by 2 dB.

Model Number	Configuration	Frequency Range (GHz)	Output Power (dBm)	Output Power with Step Attenuator (dBm)	Output Power with Electronic Step Attenuator (dBm)
MG3691C	With opt 4 or 5	< 2 <sup>a</sup>	+19	+18	+15
	STD	≥ 2 <sup>b</sup> to ≤ 10	+19	+18	+13
MG3692C	With opt 4 or 5	< 2 <sup>a</sup>	+19	+18	Not Available
	STD	≥ 2 <sup>b</sup> to ≤ 10	+19	+18	
	STD	> 10 to ≤ 20	+17	+15	
MG3693C	With opt 4 or 5	< 2 <sup>a</sup>	+15	+14	Not Available
	STD	≥ 2 <sup>b</sup> to ≤ 10	+15	+14	
	STD	> 10 to ≤ 20	+12	+10	
	STD	> 20 to ≤ 31.8	+9	+6	
MG3694C	With opt 4 or 5	< 2 <sup>a</sup>	+15	+14	Not Available
	STD	≥ 2 <sup>b</sup> to ≤ 10	+15	+14	
	STD	> 10 to ≤ 20	+12	+10	
	STD	> 20 to ≤ 40	+9	+6	
MG3695C	With opt 4 or 5	< 2 <sup>a</sup>	+12	+10	Not Available
	STD	≥ 2 <sup>b</sup> to ≤ 20	+10	+8	
	STD	> 20 to ≤ 40	+6	+3	
	STD	> 40 to ≤ 50	+3	+0	
MG3697C	With opt 4 or 5	< 2 <sup>a</sup>	+12	+10	Not Available
	STD	≥ 2 <sup>b</sup> to ≤ 20	+10	+8	
	STD	> 20 to ≤ 40	+6	+3	
	STD	> 40 to ≤ 67	+3	+0 <sup>c</sup>	

a. ≤ 2.2 GHz with Option 4

b. &gt; 2.2 GHz with Option 4

c. Typical 60 GHz to 67 GHz

**Maximum Leveled Output Power with Option 15 (High Power) Installed**

For output power with Option 22, 0.1 Hz to 10 MHz coverage, derate all specifications by 2 dB.

Model Number	Configuration	Frequency Range (GHz)	Output Power (dBm)	Output Power with Step Attenuator (dBm)	Output Power with Electronic Step Attenuator (dBm)
MG3691C	With opt 4 or 5	< 2 <sup>a</sup>	+19	+18	+15
		≥ 2 <sup>b</sup> to ≤ 10	+25	+24	+16
	Without opt 4 or 5	≥ 2 to ≤ 10	+26	+25	+16
MG3692C	With opt 4 or 5	< 2 <sup>a</sup>	+19	+18	Not Available
		2 to 10	+25	+24	
		> 10 to 16	+22	+20	
		> 16 to 20	+21	+19	
	Without opt 4 or 5	2 to 10	+26	+25	
		> 10 to 16	+25	+23	
MG3693C	With opt 4 or 5	< 2 <sup>a</sup>	+17	+16	Not Available
		≥ 2 <sup>b</sup> to ≤ 20	+21	+19	
		> 20 to ≤ 31.8	+17	+15	
	Without opt 4 or 5	≥ 2 to ≤ 20	+23	+21	
		> 20 to ≤ 31.8	+19	+17	
MG3694C	With opt 4 or 5	< 2 <sup>a</sup>	+17	+16	Not Available
		≥ 2 <sup>b</sup> to ≤ 20	+21	+19	
		> 20 to ≤ 40	+17	+15	
	Without opt 4 or 5	≥ 2 to ≤ 20	+23	+21	
		> 20 to ≤ 40	+19	+17	
MG3695C	With opt 4 or 5	< 2 <sup>a</sup>	+16	+14	Not Available
		≥ 2 <sup>b</sup> to ≤ 20	+21	+19	
		> 20 to ≤ 40	+17	+15	
		> 40 to ≤ 50	+11	+8	
	Without opt 4 or 5	≥ 2 to ≤ 20	+23	+21	
		> 20 to ≤ 40	+19	+17	
MG3697C	With opt 4 or 5	< 2 <sup>a</sup>	+16	+15	Not Available
		≥ 2 <sup>b</sup> to ≤ 20	+19	+18	
		> 20 to ≤ 40	+16	+14	
		> 40 to ≤ 67	+9	+6 <sup>c</sup>	
	Without opt 4 or 5	> 67 to ≤ 70	+3 <sup>d</sup>	0 <sup>d</sup>	
		≥ 2 to ≤ 20	+21	+19	
		> 20 to ≤ 40	+19	+16	
		> 40 to ≤ 67	+9	+6 <sup>c</sup>	
		> 67 to ≤ 70	+3 <sup>d</sup>	0 <sup>d</sup>	

a. ≤ 2.2 GHz with Option 4

b. &gt; 2.2 GHz with Option 4

c. Typical 60 GHz to 67 GHz

d. Typical

**Minimum Settable Output Power**

Without an Attenuator -20 dBm  
 With an Attenuator -120 dBm

**Minimum Leveled Output Power**

Without an Attenuator -15 dBm (-20 dBm, typical)  
 With an Attenuator -115 dBm (MG3691C, MG3692C, MG3693C, and MG3694C)  
 -105 dBm (MG3695C, and MG3697C)  
 With an Electronic Attenuator -125 dBm (MG3691C)

**Unleveled Output Power Range** (typical)

Without an Attenuator > 40 dB below max power  
 With an Attenuator > 130 dB below max power

**Power Level Switching Time** (To within specified accuracy)

Without Change in Step Attenuator < 3 ms typical  
 With Change in Step Attenuator < 20 ms typical  
 With Change in Electronic Step Attenuator < 3 ms typical  
 Power level changes across -70 dB step will result in 20 ms delay.

**Step Attenuator (Option 2)**

Adds a 10 dB/step attenuator  
 110 dB range on models ≤ 40 GHz  
 90 dB range on models > 40 GHz  
 Option 2E adds an electronic version with 120 dB range, only available on an MG3691C.  
 Option 2E is not available on units with Option 22, coverage down to 0.1 Hz.

**Accuracy and Flatness**

Step Sweep and CW Modes

Accuracy specifies the total worst case accuracy. Flatness is included within the accuracy specification.

Attenuation Below Max Power	Frequency (GHz)			
	≤ 40 <sup>a,b</sup>	40 to 50	50 to 60	60 to 67
<b>Accuracy</b>				
0 dB to 25 dB	± 1.0 dB	± 1.5 dB	± 1.5 dB	± 1.5 dB
25 dB to 60 dB	± 1.0 dB	± 1.5 dB	± 3.5 dB <sup>c</sup>	N/A
60 dB to 100 dB	± 1.0 dB	± 2.5 dB <sup>c</sup>	± 3.5 dB <sup>c</sup>	N/A
<b>Flatness</b>				
0 dB to 25 dB	± 0.8 dB	± 1.1 dB	± 1.1 dB	± 1.1 dB
25 dB to 60 dB	± 0.8 dB	± 1.1 dB	± 3.1 dB <sup>c</sup>	N/A
60 dB to 100 dB	± 0.8 dB	± 2.1 dB <sup>c</sup>	± 3.1 dB <sup>c</sup>	N/A

a. With high power Option 15, Accuracy and Flatness are ± 1.5 dB.

b. Below 20 MHz, Accuracy and Flatness are ± 1.5 dB.

c. Typical

Analog Sweep Mode

(Typical)

Attenuation Below Max Power	Frequency (GHz)			
	0.01 to 0.05	0.05 to 20	20 to 40	40 to 67
<b>Accuracy</b>				
0 dB to 12 dB	± 2.0 dB	± 2.0 dB	± 2.0 dB	± 3.0 dB
12 dB to 30 dB	± 3.5 dB	± 3.5 dB	± 4.6 dB	± 5.6 dB
30 dB to 60 dB	± 4.0 dB	± 4.0 dB	± 5.2 dB	± 6.2 dB
60 dB to 122 dB	± 5.0 dB	± 5.0 dB	± 6.2 dB	± 7.2 dB
<b>Flatness</b>				
0 dB to 12 dB	± 2.0 dB	± 2.0 dB	± 2.0 dB	± 2.5 dB
12 dB to 30 dB	± 3.5 dB	± 3.5 dB	± 4.1 dB	± 5.1 dB
30 dB to 60 dB	± 4.0 dB	± 4.0 dB	± 4.6 dB	± 5.6 dB
60 dB to 122 dB	± 5.0 dB	± 5.0 dB	± 5.2 dB	± 6.2 dB

Available Output Power

MG3692C Typical Maximum Available Output Power

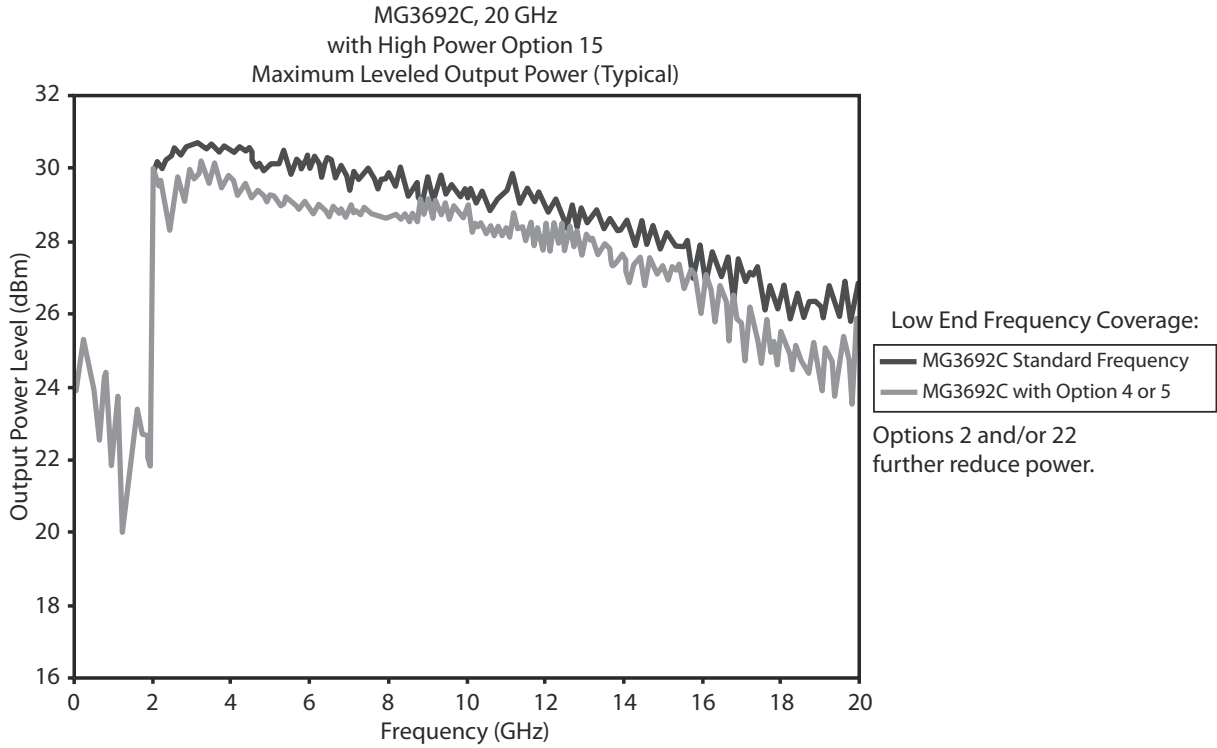

MG3694C Typical Maximum Available Output Power

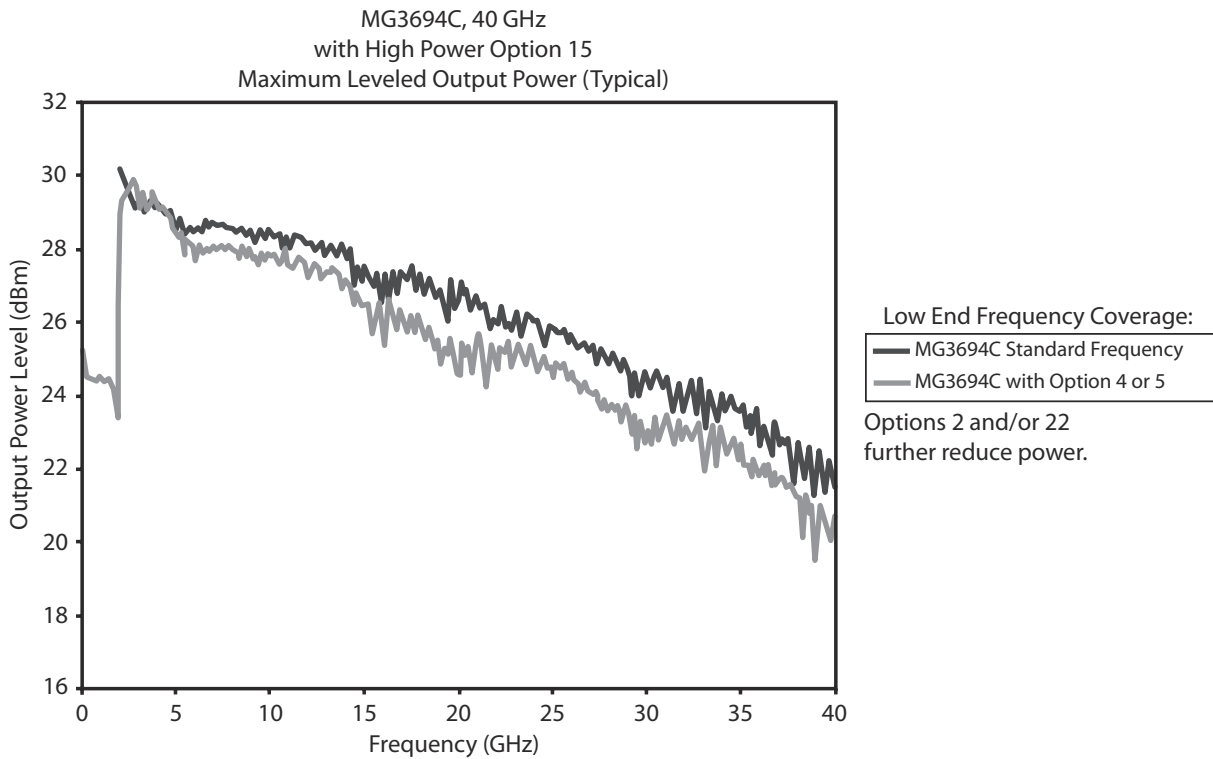

**Other RF Output Power Specifications**

Output Units	Output units selectable as either dBm or mV. Selection of mV assumes a 50 Ω load. All data entry and display are in the selected units.	
Output Power Resolution	0.01 dB or 0.001 mV	
Source Impedance	50 Ω nominal	
Source SWR (Internal Leveling)	< 2.0 typical	
Power Level Stability with Temperature	± 0.04 dB/°C typical	
Level Offset	Offsets the displayed power level to establish a new reference level.	
Output On/Off	Toggles the RF output between an Off and On state. During the Off state, the RF oscillator is turned off. The On or Off state is indicated by two LEDs located below the OUTPUT ON/OFF key on the front panel.	
RF On/Off Between Frequency Steps	System menu selection of RF On or RF Off during frequency switching in CW, Step Sweep, and List Sweep modes.	
RF On/Off During Retrace	System menu selection of RF On or RF Off during retrace.	
Internal Leveling	Power is leveled at the output connector in all modes.	
External Leveling	External Detector	Levels output power at a remote detector location. Accepts a positive or negative 0.5 mV to 500 mV input signal from the remote detector. L1 adjusts the input signal range to an optimum value. BNC connector, rear panel
	External Power Meter	Levels output power at a remote power meter location. Accepts a ± 1 V full scale input signal from the remote power meter. L1 adjusts the input signal range to an optimum value. BNC connector, rear panel
	External Leveling Bandwidth	30 kHz typical in Detector mode 0.7 Hz typical in Power Meter mode
	User Level Flatness Correction	Number of points: 2 to 801 points per table Number of tables: 5 available Entry modes: GPIB power meter or computed data
External Detector	Levels output power at a remote detector location. Accepts a positive or negative 0.5 mV to 500 mV input signal from the remote detector. L1 adjusts the input signal range to an optimum value. BNC connector, rear panel	
External Power Meter	Levels output power at a remote power meter location. Accepts a ± 1 V full scale input signal from the remote power meter. L1 adjusts the input signal range to an optimum value. BNC connector, rear panel	
External Leveling Bandwidth	30 kHz typical in Detector mode. 0.7 Hz typical in Power Meter mode.	
User Level Flatness Correction	Number of points: 2 to 801 points per table Number of tables: 5 available Entry modes: GPIB power meter or computed data	

**CW Power Sweep**

Range	Sweeps between any two power levels at a single CW frequency.
Resolution	0.01 dB/step (Log) or 0.001 mV (Linear)
Accuracy	Same as CW power accuracy
Log/Linear Sweep	Power sweep selectable as either log or linear. Log sweep is in dB; linear sweep is in mV.
Step Size	User-controlled, 0.01 dB (Log) or 0.001 mV (Linear) to the full power range of the instrument.
Step Dwell Time	Variable from 1 ms to 99 seconds. If the sweep crosses a step attenuator setting, there will be a sweep dwell of approximately 20 ms to allow setting of the step attenuator.

**Sweep Frequency/Step Power**

A power level step occurs after each frequency sweep. Power level remains constant for the length of time required to complete each sweep.

**Internal Power Monitor (Option 8)**

Sensors	Compatible with Anritsu 560-7, 5400-71, or 6400-71 series detectors Rear panel input
Range	+16 dBm to -35 dBm
Accuracy	± 1 dBm, (+16 dBm to -10 dBm) ± 2 dBm, (-10 dBm to -35 dBm)
Resolution	0.1 dBm minimum

**Modulation**

**Frequency/Phase Modulation (Option 12)**

Option 12 adds frequency and phase modulation, driven externally via a rear panel BNC connector, 50 Ω. For internal modulation, add Internal LF Generator and Pulse Generator Option 27. Frequency/Phase Modulation is not available <10 MHz with Option 22. For the most accurate FM and ΦM measurements, Bessel Null methods are used. When verifying FM and ΦM, the use of the "carrier null" technique is recommended. Measured residual FM effects must be subtracted from modulation meter measurements.

Frequency Generator  
Multiplication/Division Ratios

Frequency Range	Divide Ratio, n
< 10 MHz (Option 22)	Modulation not available
≥ 10 MHz to ≤ 15.625 MHz (Option 4)	256
> 15.625 MHz to ≤ 31.25 MHz (Option 4)	128
> 31.25 MHz to ≤ 62.5 MHz (Option 4)	64
> 62.5 MHz to ≤ 125 MHz (Option 4)	32
> 125 MHz to ≤ 250 MHz (Option 4)	16
> 250 MHz to ≤ 500 MHz (Option 4)	8
> 500 MHz to ≤ 1050 MHz (Option 4)	4
> 1050 MHz to ≤ 2200 MHz (Option 4)	2
> 10 MHz to ≤ 2000 MHz (Option 5)	1
> 2 GHz to ≤ 20 GHz	1
> 20 GHz to ≤ 40 GHz	1/2
> 40 GHz to ≤ 67 GHz	1/4

**Frequency Modulation**

Parameter	Modes	For all Frequencies other than < 2.2 GHz with Option 4		For Frequencies < 2.2 GHz with Option 4	
		Conditions	Specifications	Conditions	Specifications
Deviation	Locked	Rate = 1 kHz to 8 MHz	± [Lesser of 10 MHz or (300 * mod rate)]/n	Rate = 1 kHz to Lesser of 8 MHz or (0.03 * F <sub>carrier</sub> )	± [Lesser of 10 MHz or (300 * mod rate)]/n
	Locked Low-noise	Rate = 50 kHz to 8 MHz	± [Lesser of 10 MHz or (3 * mod rate)]/n	Rate = 50 kHz to Lesser of 8 MHz or (0.03 * F <sub>carrier</sub> )	± [Lesser of 10 MHz or (3 * mod rate)]/n
	Unlocked Narrow	Rate = DC to 8 MHz	± 10 MHz/n	Rate = DC to Lesser of 8 MHz or (0.03 * F <sub>carrier</sub> )	± 10 MHz/n
	Unlocked Wide	Rate = DC to 100 Hz	± 100 MHz/n	Rate = DC to 100 Hz	± 100 MHz/n
Bandwidth (3 dB)	Locked		1 kHz to 10 MHz		1 kHz to Lesser of 10 MHz or (0.03 * F <sub>carrier</sub> )
	Locked Low-noise		30 kHz to 10 MHz		30 kHz to Lesser of 8 MHz or (0.03 * F <sub>carrier</sub> )
	Unlocked Narrow		DC to 10 MHz		DC to Lesser of 10 MHz or (0.03 * F <sub>carrier</sub> )
	Unlocked Wide		DC to 100 Hz		DC to 100 Hz
Flatness	Locked	Rate = 10 kHz to 1 MHz	± 1 dB relative to 100 kHz	Rate = 10 kHz to Lesser of 1 MHz or (0.01 * F <sub>carrier</sub> )	± 1 dB relative to 100 kHz
Accuracy	Locked and Low-noise Unlocked Narrow	Rate = 100 kHz Sine wave Int. or 1 V <sub>pk</sub> Ext.	10 % (5 % typical)	Rate = 100 kHz sine wave Int. or 1 V <sub>pk</sub> Ext.	10% (5% typical)
Incidental AM	Locked and Low-noise Unlocked Narrow	1 MHz Rate ± 1 MHz Deviation	< 2 % typical	Rate and Dev. = Lesser of 1 MHz or (0.01 * F <sub>carrier</sub> )	< 2% typical
Harmonic Distortion	Locked	10 kHz Rate, ± 1 MHz Deviation	< 1 %	Rate = 10 kHz, Dev. = ± 1 MHz /n	< 1%
External Sensitivity	Locked	± 1 V maximum input	± (10 kHz/V to 20 MHz/V)/n	± 1 V <sub>pk</sub> maximum input	± (10 kHz/V to 20 MHz/V)/n
	Locked Low-noise		± (10 kHz/V to 20 MHz/V)/n		± (10 kHz/V to 20 MHz/V)/n
	Unlocked Narrow		± (10 kHz/V to 20 MHz/V)/n		± (10 kHz/V to 20 MHz/V)/n
	Unlocked Wide		± (100 kHz/V to 100 MHz/V)/n		± (100 kHz/V to 100 MHz/V)/n

**Phase Modulation**

Parameter	Modes	For all Frequencies other than < 2.2 GHz with Option 4		For Frequencies < 2.2 GHz with Option 4	
		Conditions	Specifications	Conditions	Specifications
Deviation	Narrow	Rate= DC to 8 MHz	$\pm$ [Lesser of 3 rad or (5 MHz/mod rate)]/n	Rate = DC to Lesser of 8 MHz or $(0.03 * F_{carrier})$	$\pm$ [Lesser of 3 rad or (5 MHz/mod rate)]/n
	Wide	Rate = DC to 1 MHz	$\pm$ [Lesser of 400 rad or (10 MHz/mod rate)]/n	Rate = DC to Lesser of 1 MHz or $(0.03 * F_{carrier})$	$\pm$ [Lesser of 400 rad or (10 MHz/mod rate)]/n
Bandwidth (3 dB)	Narrow		DC to 10 MHz		DC to Lesser of 10 MHz or $(0.03 * F_{carrier})$
	Wide		DC to 1 MHz		DC to Lesser of 1 MHz or $(0.03 * F_{carrier})$
Flatness	Narrow	Rate= DC to 1 MHz	$\pm$ 1 dB relative to 100 kHz	Rate = DC to (Lesser of 1 MHz or $(0.01 * F_{carrier})$ )	$\pm$ 1 dB relative to 100 kHz rate
	Wide	Rate = DC to 500 kHz	$\pm$ 1 dB relative to 100 kHz	Rate = DC to Lesser of 500 kHz or $(0.01 * F_{carrier})$	$\pm$ 1 dB relative to 100 kHz rate
Accuracy	Narrow and Wide	100 kHz Internal or $1 V_{pk}$ External, sine	10%	100 kHz Internal or $1 V_{pk}$ External, sine	10%
External Sensitivity	Narrow	$\pm$ 1 V maximum input	$\pm$ (0.0025 rad/V to 5 rad/V)/n	$\pm$ 1 $V_{pk}$ maximum input	$\pm$ (0.0025 rad/V to 5 rad/V)/n
	Wide		$\pm$ (0.25 rad/V to 500 rad/V)/n		$\pm$ (0.25 rad/V to 500 rad/V)/n

**Amplitude Modulation (Option 14)**

Option 14 adds amplitude modulation, driven externally via a rear panel BNC connector 50  $\Omega$ . For internal modulation, add Internal LF and Pulse Generators Option 27.

All amplitude modulation specifications apply at 50% depth, 1 kHz rate, with RF level set 6 dB below maximum specified leveled output power, unless otherwise noted. Amplitude Modulation is not available < 10 MHz with Option 22.

AM Depth (typical)	0 % to 90 % linear; 20 dB log
AM Bandwidth (3 dB)	DC to 50 kHz minimum DC to 100 kHz typical Typical below 2.2 GHz, when ordered with Options 4 and 15
Flatness (DC to 10 kHz rates)	$\pm$ 0.3 dB
Accuracy	Reading $\pm$ 5 %
Distortion	< 5 % typical
Incidental Phase Modulation (30 % depth, 10 kHz rate)	< 0.2 radians typical
External AM Input	Log AM or Linear AM input Rear-panel BNC (50 $\Omega$ input impedance) For internal modulation, add LF Generator Option 27.
Sensitivity	Log AM: Continuously variable from 0 dB per volt to 25 dB per volt. Linear AM: Continuously variable from 0% per volt to 100% per volt.
Maximum Input	$\pm$ 1 $V_{pk}$

<b>Pulse Modulation (Option 26)</b>	Option 26 adds pulse modulation, driven externally via a rear panel BNC connector, TTL. For internal modulation, add Internal LF and Pulse Generators Option 27. Pulse modulation specifications apply at maximum rated power, unless otherwise noted. Pulse modulation is not available < 10 MHz with Option 22.
On/Off Ratio	> 80 dB (> 70 dB with high power Option 15)
Minimum Leveled Pulse Width	100 ns, ≥ 1 GHz 1 μs, < 1 GHz
Minimum Unleveled Pulse Width	< 10 ns
Level Accuracy Relative to CW (100 Hz to 1 MHz PRF)	± 0.5 dB, ≥ 1 μs pulse width ± 1.0 dB, < 1 μs pulse width
Pulse Delay (typical)	50 ns in External Mode
PRF Range	DC to 10 MHz, unleveled 100 Hz to 5 MHz, leveled
External Input	Rear-panel BNC For internal modulation, add Pulse Generator Option 27.
Drive Level	TTL compatible input
Input Logic	Positive-true or negative-true, selectable from modulation menu

Frequency Range	Rise and Fall Time (10% to 90%)	Overshoot	Pulse Width Compression	Video Feedthrough
≥ 10 MHz to < 31.25 MHz (Opt. 4)	400 ns <sup>a</sup>	33 % <sup>a</sup>	40 ns <sup>a</sup>	± 70 mV <sup>a</sup>
≥ 31.25 MHz to < 125 MHz (Opt. 4)	90 ns <sup>a</sup>	22 % <sup>a</sup>	12 ns <sup>a</sup>	± 130 mV <sup>a</sup>
≥ 125 MHz to < 500 MHz (Opt. 4)	33 ns <sup>a</sup>	11 % <sup>a</sup>	12 ns <sup>a</sup>	± 70 mV <sup>a</sup>
≥ 500 MHz to < 2200 MHz (Opt. 4)	15 ns <sup>a</sup>	10 %	12 ns <sup>a</sup>	± 50 mV <sup>a</sup>
≥ 10 MHz to < 1000 MHz (Opt. 5)	15 ns, 10 ns <sup>a</sup>	10 %	8 ns <sup>a</sup>	± 30 mV <sup>a</sup>
≥ 1 GHz to < 2 GHz (Opt. 5)	10 ns, 5 ns <sup>a</sup>	10 %	8 ns <sup>a</sup>	± 30 mV <sup>a</sup>
≥ 2 GHz to 67 GHz <sup>b</sup>	10 ns, 5 ns <sup>a</sup>	10 % <sup>c</sup>	8 ns <sup>a</sup>	± 30 mV <sup>a</sup>

a. Typical values.

b. Rise time and Pulse Width Compression, > 20 GHz, degrades by 2 ns, with High Power Option 15.

c. For 50 GHz and 67 GHz units, overshoot > 40 GHz is 20 % typical at rated power.

**Internal LF and Pulse Generators (Option 27)**

An internal pulse generator and two internal waveform generators are added, one providing a frequency or phase modulating signal and the other an amplitude modulating signal. This Internal LF and Pulse Generators option can only be ordered in combination with either FM/ΦM, AM, or Pulse options, 12, 14, and 26 respectively.

Waveforms	Sinusoid, square-wave, triangle, positive ramp, negative ramp, Gaussian noise, uniform noise (Check Option 10 for User-defined.)
Rate	0.1 Hz to 10 MHz sinusoidal 0.1 Hz to 1 MHz square-wave, triangle, ramps
Resolution	0.1 Hz
Accuracy	Same as instrument timebase ± 0.014 Hz
Waveform Outputs	Two BNC connectors on the rear panel, FM/ΦM OUT and AM OUT
Pulse Modes	Singlet, doublet, triplet, quadruplet
Pulse Triggers	Free-run, triggered, gated, delayed, triggered with delay, swept-delay
Pulse Inputs/Outputs	Video pulse and sync out, rear-panel BNC connectors

Pulse Parameter	Selectable Clock Rate	
	Narrow (100 MHz)	Wide (10 MHz)
Pulse Width	10 ns to 160 ms	100 ns to 1.6 s
Pulse Period <sup>a</sup>	100 ns to 160 ms	600 ns to 1.6 s
Variable Delay	Singlet	0 ms to 160 ms
	Doublet	100 ns to 160 ms
	Triplet	100 ns to 160 ms
	Quadruplet	100 ns to 160 ms
Resolution	10 ns	100 ns
Accuracy	10 ns (5 ns typical)	10 ns (5 ns typical)

a. Period must be longer than the sum of delay and width by 5 clock cycles minimum.



**Ultra-Stable Phase Tracking (Option 36)**

	Option 36 enables up to three MG3690C units fitted with Option 3, 3X, or 3XA to phase track with a very high degree of stability. Option 36 provides additional rear panel connectors to link internal reference signals together.
100 MHz Reference Output	Provides the reference signal to drive up to two other MG3690C generators. All MG3690C generators must have Option 36 and either Option 3, 3X, or 3XA. This signal is only intended for use with other Option 36 instruments.
100 MHz Reference Input	Accepts the 100 MHz reference signal from another MG3690C fitted with Option 36. This input is only intended for use with other Option 36 instruments.
Phase Drift	< ± 1° over 5 seconds (typical) < ± 1.5° over 100 seconds (typical), after 24 hours warm-up time

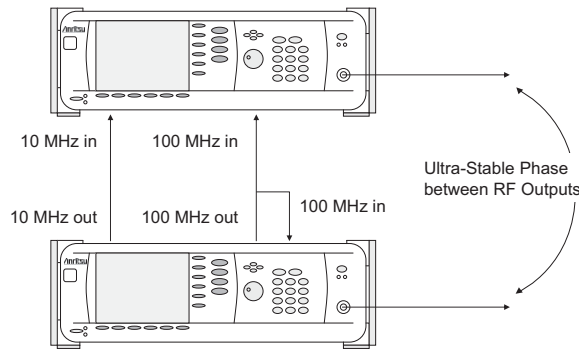

**IF Up-Conversion (Option 7)**

Option 7 adds an internal mixer that can be used for the generic up-conversion of an IF signal. The mixer’s RF, LO, and IF ports are made available at the rear panel of the MG3690C via three female K Connectors. The typical application will feed the MG3690C microwave output, which can be moved to the rear panel (via Option 9K) to the mixer’s LO port. An external IF signal will be fed to the mixer’s IF port. The new up-converted signal will be available at the mixer’s RF port.

Mixer Type	Double Balanced
RF, LO Range	1 GHz to 40 GHz
IF Range	DC to 700 MHz
Conversion Loss	10 dB Typical
Max Power into any Port	23 dBm @ 25 °C
Isolation, RF to LO	30 dB
LO Drive Level (recommended)	+10 dBm to +13 dBm
Input P1 dB	+3 dBm Typical

The IF Up-Conversion option is particularly useful to create a microwave frequency IQ-modulated signal. Lower frequency IQ-modulated RF sources are readily available, such as the Anritsu MG3700A. The Option 7 IF input can be used to feed in an IQ-modulated signal from an MG3700A, up-converting it to as high as 40 GHz with an MG3694C. A typical setup is shown below.

**User-Defined Modulation Waveform Software (Option 10)**

An external software package provides the ability to download user-defined waveforms into the internal LF Generator's (Option 27) memory. The MG3690C provides as standard with the LF Generator sinusoidal, square-wave, triangle, positive ramp, Gaussian noise, and uniform noise waveforms.

Two look-up tables of 65,536 points can be used to generate two pseudo-random waveforms, one for amplitude modulation and the other for frequency or phase modulation. The download files are simple space-delimited text files containing integer numbers between 0 and 4095, where 0 corresponds to the minimum modulation level and 4095 the maximum.

In addition to the capability of downloading custom waveforms, the software offers a virtual instrument modulation panel. Custom modulation setups with user waveforms can be stored for future use. For IFF signal simulation, the internal generators can be synchronized. They can also be disconnected from the internal modulators, making the low frequency waveforms available at the rear panel for external purposes.

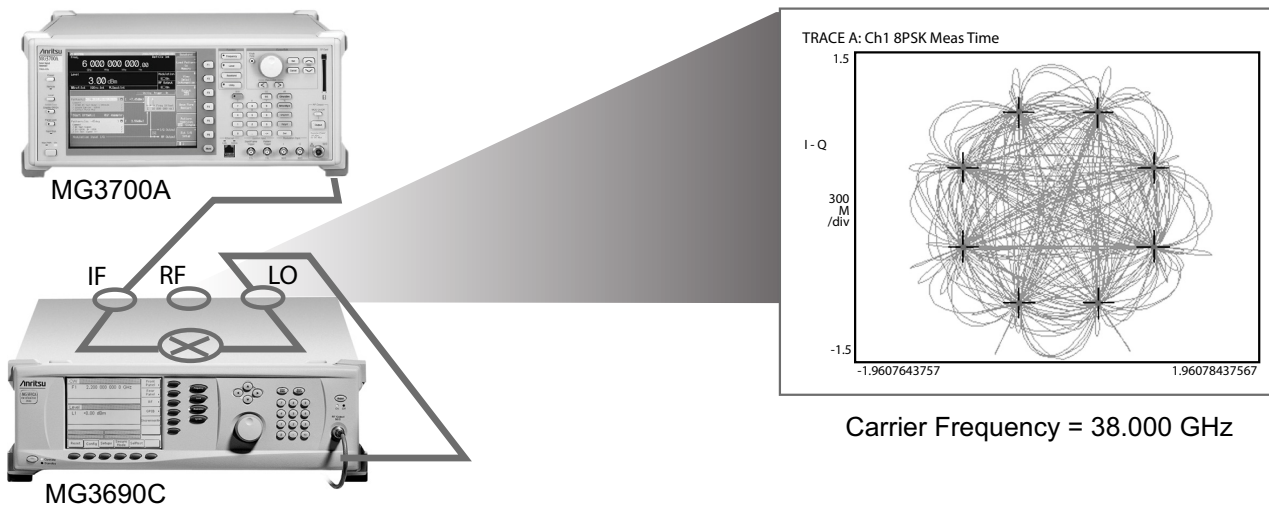

**Scan Modulation (Option 20)**

Option 20 adds a microwave linearly controlled attenuator to provide deep AM capability. This modulator is inserted outside the leveling loop but before the optional step attenuator. It is switched in and out of the RF path. Scan modulation is driven externally only.

One application of this feature is storing an antenna pattern wave form in memory and using it to feed the external input to the scan modulator, Option 20.

Frequency Range	2 GHz to 18 GHz
Attenuation Range	0 dB to 60 dB
Flatness/Accuracy	± 1.5 dB/± 1.5 dB, 0 dB to 40 dB ± 3 dB/± 2 dB, 40 dB to 60 dB
Step Response	< 1 μs
Sensitivity	-10 dB/V
Modulation Bandwidth	20 kHz (small signal) 5 kHz (large signal)
Insertion Loss	< 6 dB (when engaged)
Input	Rear Panel BNC connector High Impedance

**Millimeter-wave Frequency Coverage**

**Millimeter-Wave Multiplier 2000-1694 Series**

**Introduction** 2000-1694 series external waveguide output multipliers are available for banded frequency coverage up to 500 GHz. These external multipliers require at a minimum, an MG3692C with 20 GHz coverage. The output power required to drive the modules is +10 dBm. They can be powered from an external power supply (+12 VDC, 1.5 A typical) using the supplied double banana power cord, or from the 40-187-R DC Power Supply and 2000-1710-R Millimeter-wave Power Supply Adapter. Both included with the modules.

2000-1694 series multipliers have a saturated, unlevelled, output power, yet their inherent flatness is exceptional. Modulating the input drive will indeed modulate the output, except for the case of Amplitude Modulation. Since the output is saturated, Amplitude Modulation is not recommended with these millimeter-wave modules. Frequency and Phase Modulation is possible, but the achieved deviation will be multiplied based on the multiplication factor of the module. Pulse modulation is also possible, with even sharper rise and fall times than the input. All modulation performances are not specified.

For ease of operation, the MG3690C allows the user to enter a frequency scaling factor, the module's multiplication factor, which will be used only for purposes of displaying the proper frequency at the output of the millimeter-wave module, on the MG3690C front panel display.

Millimeter-Wave Multiplier 2000-1694 Series are not for use with MG3690C Option 18.



Multiplier P/N <sup>a b c</sup>	2000-1694-15-R	2000-1694-12-R	2000-1694-10-R	2000-1694-08-R	2000-1694-06-R	2000-1694-05-R	2000-1694-03-R	2000-1694-02-R
Frequency	50 GHz to 75 GHz	60 GHz to 90 GHz	75 GHz to 110 GHz	90 GHz to 140 GHz	110 GHz to 170 GHz	140 GHz to 220 GHz	220 GHz to 325 GHz	325 GHz to 500 GHz
Waveguide Output Flange <sup>d</sup>	WR-15 (008)	WR-12 (009)	WR-10 (010)	WR-08 (M08)	WR-06 (M06)	WR-05 (M05)	WR-03 (M03)	WR-02.2 (M02.2)
Output Power (typical)	+8 dBm	+6 dBm	+7 dBm	-5 dBm	-9 dBm	-15 dBm	-25 dBm <sup>e</sup>	-27 dBm <sup>e</sup>
Output Flatness (typical) (Unlevelled)	± 2 dB	± 2 dB	± 3 dB	—	—	—	—	—
Output Match	> 11.7 dB	> 11.7 dB	> 11.7 dB	> 11.7 dB	> 11.7 dB	> 11.7 dB	6 dB (typical)	6 dB (typical)
Multiplication Factor (m)	x4	x6	x6	x8	x12	x12	x18	x30
Input Frequency	12.5 GHz to 18.8 GHz	10.0 GHz to 15.0 GHz	12.5 GHz to 18.4 GHz	11.2 GHz to 17.5 GHz	9.1 GHz to 14.2 GHz	11.6 GHz - 18.4 GHz	12.2 GHz to 18.1 GHz	10.8 GHz to 16.7 GHz
Frequency Accuracy	(Synthesizer Accuracy x m)							
Frequency Resolution	(Synthesizer Resolution x m)							
Manual Adjustable Attenuator <sup>f</sup>	25 dB min							N/A
Harmonics and Spurious <sup>g,h</sup>	-20 dBc (typical)							N/A
Input Power Required	+10 dBm							
RF Input Connector	SMA (female)							
DC Power	12 VDC, 1.5 A (double-banana power cord included) <sup>b</sup>							
Dimensions	145 mm x 110 mm x 72 mm (not including feet, interfaces, or optional manual attenuation adjuster)							
Weight	< 1 kg							
Temperature	+20 °C to +30 °C							

- a. These millimeter-wave modules are produced by OML Inc. (Oleson Microwave Labs), located in Morgan Hill, CA., with mutual collaborative experiences over many years. For detailed and up-to-date specifications, please call OML, Inc. or visit their website at <http://www.omlinc.com>.
- b. Multipliers require power from an external power supply (+12 VDC, 1.5 A typical) using the supplied double banana power cord, or from the 40-187-R DC Power Supply and 2000-1710-R Millimeter-wave Power Supply Adapter (both included with the modules).
- c. Warranty period for the 2000-1694 Series is one year.
- d. Waveguide output flanges are per MIL-DTL-3922/67D (UG387/U-M).
- e. Output power is estimated.
- f. Available as an option. To order, add "A" to multiplier module part number (for example, 2000-1694-15A-R). Not available with 2000-1694-02-R.
- g. In-band mixing products typically ≤ -15 dBc in the lower 10 % of the waveguide band.
- h. As relates to multiplied output frequencies.

## Inputs and Outputs

	Refer to the illustration <a href="#">on page 21</a> . Connectors may be available but not active if option is not ordered. Options (7 & 18), (7 & 20), (8 & 9) are mutually exclusive, as they share the same rear panel space.
EXT ALC IN	Provides for leveling the RF output signal externally with either a detector or power meter. Signal requirements are shown in the RF Output specifications. BNC type, rear panel
RF OUTPUT (Option 9)	Provides for RF output from 50 $\Omega$ source impedance. Option 9 moves the RF Output connector from the front to the rear panel. Note: Option 9 and Option 8 are mutually exclusive, as they share the same rear panel space. K Connector (female) $f_{\max} \leq 40$ GHz V Connector (female) $f_{\max} \geq 40$ GHz
10 MHz REF IN	Accepts an external 10 MHz $\pm$ 50 Hz, 0 dBm to +20 dBm time-base signal. Automatically disconnects the internal high-stability time-base option, if installed. 50 $\Omega$ impedance BNC type, rear panel
10 MHz REF OUT	Provides a 1 V <sub>p-p</sub> , AC coupled, 10 MHz signal derived from the internal frequency standard. 50 $\Omega$ impedance BNC type, rear panel
100 MHz REF IN (Option 36)	Accepts the 100 MHz signal from an MG3690C with Option 36 for ultra-stable phase tracking.
100 MHz REF OUT (Option 36)	Provides the 100 MHz signal for an MG3690C with Option 36 ultra-stable phase tracking.
HORIZ OUT (Horizontal Sweep Output)	Provides 0 V at beginning and +10 V at end of sweep, regardless of sweep width. In CW mode, the voltage is proportional to frequency between 0 V at low end and +10 V at the high end of the range. In CW mode, if CW RAMP is enabled, a repetitive, 0 V to +10 V ramp is provided. BNC type, rear panel
EFC IN	Provides the capability to frequency modulate the internal crystal oscillator, allowing phase locking of the synthesizer inside an external lock loop. Specifications are <a href="#">on page 2</a> . BNC type, rear panel
AUX I/O (Auxiliary Input/Output)	Provides for most of the rear panel BNC connections through a single, 25-pin, D type connector. Supports master-slave operation with another synthesizer or allows for a single-cable interface with the Model 56100A Scalar Network Analyzer and other Anritsu instruments. See Aux I/O Pin Descriptions <a href="#">on page 21</a> . Also provides an Ethernet factory default IP address reset function via pin 19. 25 pin D-type, rear panel
SERIAL I/O	Provides access to RS-232 terminal ports to support service and calibration functions and master-slave operations. RJ45 type, rear panel
ETHERNET (10/100 Base-T LAN) I/O	Provides input/output connections for an Ethernet interface. RJ45 type, rear panel
IEEE-488 GPIB	Provides input/output connections for the General Purpose Interface Bus (GPIB). Type 57, rear panel
DC OUT (Option 18)	Supplies +15 VDC, 1 A (nominal) Note: Option 18 and Option 7 are mutually exclusive, as they share the same rear panel space.
RF, LO, IF (Option 7)	Provides access to an internal IF up-conversion mixer. Note: Option 7 and 18, as well as Option 7 and 20 are mutually exclusive, as they share the same rear panel space. K Connector (female, 3 each), rear panel
PULSE TRIG IN (Option 26)	Accepts an external TTL compatible signal to pulse modulate the RF output signal or to trigger or to gate the optional internal pulse generator. BNC type, rear panel
PULSE SYNC OUT (Option 27)	Provides a TTL compatible signal, synchronized to the internal pulse modulation output. BNC type, rear panel
PULSE VIDEO OUT (Option 27)	Provides a video modulating signal from the internal pulse generator. BNC type, rear panel
AM IN (Option 14)	Accepts an external signal to amplitude modulate the RF output signal. 50 $\Omega$ impedance BNC type, rear panel
FM/ $\Phi$ M IN (Option 12)	Accepts an external signal to frequency or phase modulate the RF output signal. 50 $\Omega$ impedance BNC type, rear panel
AM OUT (Option 27)	Provides the amplitude modulation waveform from the internal LF generator. BNC type, rear panel.
FM/ $\Phi$ M OUT (Option 27)	Provides the frequency or phase modulation waveform from the internal LF generator. BNC type, rear panel
SCAN MOD IN (Option 20)	Accepts an external signal to scan modulate the RF output signal. Note: Option 20 and Option 7 are mutually exclusive, as they share the same rear panel space. High Impedance BNC type, rear panel
POWER MONITOR IN (Option 8)	Accepts an external detector for power monitoring. Custom type, rear panel Note: Options 8 and 9 are mutually exclusive, as they share the same rear panel space.



MG3690C Rear Panel

Aux I/O Pin Descriptions

Pin	Description	Pin	Description
1	Horizontal Output	14	V/GHz Output
2	Chassis Ground	15	End-of-Sweep Input
3	Sequential Sync Output	16	End-of-Sweep Output
4	Low Alternate Enable Output	17	N/C
5	Marker Output	18	Sweep Dwell Input
6	Retrace Blanking Output	19	Ethernet Default Address Reset
7	Low Alternate Sweep Output	20	Bandswitch Blanking Output
8	Chassis Ground	21	Master Reset
9	N/C	22	Horizontal Sweep Input
10	Sweep Dwell Output	23	Horizontal Sweep Input Return
11	Lock Status Output	24	Chassis Ground
12	Penlift	25	Memory Sequencing Input
13	External Trigger Input		

Ordering Information

Models

MG3691C	2 GHz to 10 GHz Signal Generator
MG3692C	2 GHz to 20 GHz Signal Generator
MG3693C	2 GHz to 31.8 GHz Signal Generator
MG3694C	2 GHz to 40 GHz Signal Generator
MG3695C	2 GHz to 50 GHz Signal Generator
MG3697C	2 GHz to 67 GHz Signal Generator (operational to 70 GHz)

Standard Accessories

	(included)
2300-469	Software for MG3690X Operation Manual Programming Manual SCPI Programming Manual IVI Drivers Technical Datasheet
2000-1732-R	CAT-7 shielded, twisted-pair, Ethernet cable, 10 ft.
Miscellaneous	Power Cord with plug-type and rating determined by destination country. 3 Year Factory Warranty Options and Accessories. 2 Year Factory Warranty for 2000-1694 Series.

Options		
	MG3690C/1A	Rack Mount with slides. Rack mount kit containing a set of track slides (90 degree tilt capability), mounting ears, and front panel handles to let the instrument be mounted in a standard 19-inch equipment rack.
	MG3690C/1B	Rack Mount without slides. Modifies rack mounting hardware to install unit in a console that has mounting shelves. Includes mounting ears and front panel handles.
	MG3690C/2A, MG3690C/2B, MG3690C/2C	Mechanical Step Attenuator. Adds a 10 dB/step attenuator. Rated RF output power is reduced. This option comes in different versions, based on instrument configuration.
	MG3690C/2E	Electronic Step Attenuator. Adds a 10 dB/step electronic attenuator with a 120 dB range for the MG3691C. Rated RF output power is reduced. Not available with Option 20 or 22.
	MG3690C/3	Ultra Low Phase Noise. Adds new modules to significantly reduce SSB phase noise. Not available with Option 3X or 3XA.
	MG3690C/3X	Premium Phase Noise. Improves Option 3 < 1 kHz offset. Not available with Option 3 or 3XA.
	MG3691C/3XA	Premium Phase Noise ≤ 10 GHz. Improves Option 3 < 1 kHz offset. Not available with Options 3 or 3X.
	MG3690C/4	8 MHz to 2.2 GHz RF coverage, Ultra-Low Phase Noise version. Uses a digital down converter to significantly reduce SSB phase noise. All specifications apply ≥ 10 MHz.
	MG3690C/5	8 MHz to 2 GHz RF Coverage. Uses an analog down converter. All specifications apply ≥ 10 MHz.
	MG3690C/6	Analog Sweep Capability. When used with Option 4, analog sweep capability is limited to ≥ 500 MHz
	MG3690C/7	IF Up-Conversion. Adds an internal 40 GHz mixer for up-converting an IF signal. Not available with MG3695C, MG3697C, or with Options 18, 20 or 36.
	MG3690C/8	Power Monitor. Adds internal power measurement capability. Not available with Option 9.
	MG3690C/9V, MG3690C/9K	Rear Panel Output Moves the RF output connector to the rear panel. Not available with Option 8. This option comes in different versions, based on instrument configuration
	MG3690C/10	User-Defined Modulation Waveform Software. External software package provides the ability to download user-defined waveforms into the memory of the internal waveform generator, serially or via GPIB or Ethernet. External PC and an instrument with LF Generator, Option 27, are required.
	MG3690C/12	Frequency and Phase Modulation. External, via a rear panel BNC connector. For internal modulation capability, requires addition of an LF Generator, Option 27.
	MG3690C/14	Amplitude Modulation. External, via a rear panel BNC connector. For internal modulation capability, requires addition of an LF Generator, Option 27.
	MG3690C/15A, MG3690C/15B, MG3690C/15C, MG3690C/15D	High Power. Adds high-power RF components to the instrument to increase its output power level. This option comes in different versions, based on instrument configuration.
	MG3690C/16	High Stability Time Base. Adds an ovenized, 10 MHz crystal oscillator as a high-stability time base.
	MG3690C/17	Delete Front Panel. Deletes the front panel for use in remote control applications where a front panel display and keyboard control are not needed. Only available with Options 1A or 1B.
	MG3690C/18	DC Output. Adds a rear panel BNC Twinax connector supplying +15 VDC, 1A (nominal). Not available with Option 7 or 15x.
	MG3690C/20	Scan Modulation. Adds an internal Scan modulator for simulating high-depth amplitude modulated signals. Requires an external modulating signal input capability. Not available on models MG3693C, MG3694C, MG3695C, MG3697C, or with Options 2E, 7, 15X, or 22.
	MG3690C/22	0.1 Hz to 10 MHz Audio coverage. Uses a DDS for coverage down to approximately DC. When adding Option 22, the output power is derated by 2 dB. Frequency resolution below 10 MHz is 0.02 Hz. No modulation is available in the 0.1 Hz to 10 MHz band. Not available without Option 4 or 5, or with Option 20 or 2E.
	MG3690C/26A, MG3690C/26B	Pulse Modulation. External, via a rear panel BNC connector. For internal modulation capability, requires addition of a Pulse Generator, Option 27. This option comes in different versions, based on instrument configuration.
	MG3690C/27	Internal LF and Pulse Generators. Provides modulation waveforms for internal AM (if Option 14 installed), FM (if Option 12 installed), ΦM (if Option 12 installed) and Pulse (if Option 26A/B installed). Not available without Option 12, 14, or 26.
	MG3690C/28A, MG3690C/28B	Analog Modulation Suite. For ease of ordering and package pricing, this option bundles Options 12, 14, 26 and 27, offering internal and external AM, FM, ΦM, and Pulse Modulation. This option comes in different versions, based on instrument configuration.
	MG3690C/36	Ultra-Stable Phase Tracking. Provides the capability for ultra-stable phase tracking between instruments using the internal 100 MHz reference. Requires Option 3, 3X, or 3XA. Not available with Option 7 or with both Option 18 and 20 together.

<b>Accessories</b>	34RKNF50 ND36329 63270 2300-469 806-97	DC to 20 GHz, Ruggedized Type N female adapter for units with a K connector output MASTER/SLAVE interface cable set Transit case (16 kg, 66 cm x 41 cm x 81 cm, roll-away on four wheels) IVI Driver, includes LabView® driver Aux I/O Cable, 25 pin to BNC: Provides BNC access to Aux I/O Data Lines: Sequential Sync, Marker Out, Bandswitch Blanking, Retrace Blanking, Sweep Dwell In, V/GHz, Horizontal Out.
<b>Millimeter Wave Accessories</b>	2000-1694-15-R 2000-1694-12-R 2000-1694-10-R 2000-1694-08-R 2000-1694-06-R 2000-1694-05-R 2000-1694-03-R 2000-1694-02-R 40-187-R 2000-1710-R	Note: To order a multiplier with an optional manually adjustable attenuator, add an "A" to the multiplier module part number (for example, 2000-1694-15A-R). Not available with 200-1694-02-R 50 GHz to 75 GHz V band Multiplier Source Module, WR-15 60 GHz to 90 GHz E band Multiplier Source Module, WR-12 75 GHz to 110 GHz W band Multiplier Source Module, WR-10 90 GHz to 140 GHz F band Multiplier Source Module, WR-08 110 GHz to 170 GHz D band Multiplier Source Module, WR-06 140 GHz to 220 GHz G band Multiplier Source Module, WR-05 220 GHz to 325 GHz H band Multiplier Source Module, WR-03 325 GHz to 500 GHz Multiplier Source Module, WR-02.2 DC Power Supply. Included with Multiplier Source Module. Millimeter wave Power Supply Adapter. Included with Multiplier Source Module.
<b>Manuals</b>	10370-10373 10370-10374 10370-10375 10370-10376	Operation Manual Programming Manual (Native) Programming Manual (SCPI) Maintenance Manual
<b>Upgrades</b>		Economical upgrades are available to upgrade any model to any higher performing model. Consult Anritsu for details.

**MG3690C Option Configuration Guide**

Models	Options																
	OPT 1		OPT 2				OPT 3	OPT 3X	OPT 3XA	OPT 4	OPT 5	OPT 6	OPT 7	OPT 8	OPT 9	OPT 10	OPT 12
	1A	1B	2A	2B	2C	2E								9K	9V		
MG3691C	•	•	•			• <sup>a,b</sup>	• <sup>c</sup>		• <sup>c</sup>	• <sup>d</sup>	•	• <sup>e,f,g</sup>	• <sup>h</sup>	• <sup>h</sup>		• <sup>i</sup>	•
MG3692C	•	•	•				• <sup>c</sup>	• <sup>c</sup>	• <sup>d</sup>	• <sup>d</sup>	•	• <sup>e,f,g</sup>	• <sup>h</sup>	• <sup>h</sup>		• <sup>i</sup>	•
MG3693C	•	•		•			• <sup>c</sup>	• <sup>c</sup>	• <sup>d</sup>	• <sup>d</sup>	•	• <sup>e,f,g</sup>	• <sup>h</sup>	• <sup>h</sup>		• <sup>i</sup>	•
MG3694C	•	•		•			• <sup>c</sup>	• <sup>c</sup>	• <sup>d</sup>	• <sup>d</sup>	•	• <sup>e,f,g</sup>	• <sup>h</sup>	• <sup>h</sup>		• <sup>i</sup>	•
MG3695C	•	•			•		• <sup>c</sup>	• <sup>c</sup>	• <sup>d</sup>	• <sup>d</sup>	•		• <sup>h</sup>		• <sup>i</sup>	• <sup>i</sup>	•
MG3697C	•	•			•		• <sup>c</sup>	• <sup>c</sup>	• <sup>d</sup>	• <sup>d</sup>	•		• <sup>h</sup>		• <sup>i</sup>	• <sup>i</sup>	•

Models	Options (continued)																	
	OPT 14	OPT 15				OPT 16	OPT 17	OPT 18	OPT 20	OPT 22	OPT 26		OPT 27	OPT 28		OPT 36	OPT 98	OPT 99
		15A	15B	15C	15D						26A	26B		28A	28B			
MG3691C	•	• <sup>f</sup>				•	• <sup>j</sup>	• <sup>e,f,k</sup>	• <sup>a,k</sup>	• <sup>l,b</sup>	•		• <sup>m</sup>	• <sup>n</sup>		• <sup>o,g,k</sup>	•	•
MG3692C	•	• <sup>f</sup>				•	• <sup>j</sup>	• <sup>e,f,k</sup>	• <sup>a,k</sup>	• <sup>l</sup>	•		• <sup>m</sup>	• <sup>n</sup>		• <sup>o,g,k</sup>	•	•
MG3693C	•		• <sup>f</sup>			•	• <sup>j</sup>	• <sup>e,f,k</sup>		• <sup>l</sup>	•		• <sup>m</sup>	• <sup>n</sup>		• <sup>o,g,k</sup>	•	•
MG3694C	•		• <sup>f</sup>			•	• <sup>j</sup>	• <sup>e,f,k</sup>		• <sup>l</sup>	•		• <sup>m</sup>		• <sup>n</sup>	• <sup>o,g,k</sup>	•	•
MG3695C	•			• <sup>f</sup>		•	• <sup>j</sup>	• <sup>f,k</sup>		• <sup>l</sup>	•		• <sup>m</sup>		• <sup>n</sup>	• <sup>o,g,k</sup>	•	•
MG3697C	•				• <sup>f</sup>	•	• <sup>j</sup>	• <sup>k</sup>		• <sup>l</sup>	•		• <sup>m</sup>		• <sup>n</sup>	• <sup>o,g,k</sup>	•	•

- a. Option 20 cannot be ordered with Option 2E, Option 7, 15 or 22.
- b. Option 2E cannot be ordered with Option 22.
- c. Options 3, 3X, and 3XA cannot be ordered together.
- d. Options 4 and 5 cannot be ordered together.
- e. Options 7 and 18 cannot be ordered together. Also, Options 7 and 20 cannot be ordered together.
- f. Option 18 cannot be ordered with Option 15 or 7. Option 15 cannot be ordered with Option 20.
- g. Options 7 and 36 cannot be ordered together.
- h. Option 8 cannot be ordered along with Option 9.
- i. Option 10 can only be ordered with either Options 27 or 28.
- j. Option 17 can only be ordered with either Option 1A or 1B.
- k. Option 36 can be ordered with either option 18 or 20, but cannot be ordered with both.
- l. Option 22 can only be ordered with either Option 4 or 5. Option 22 cannot be ordered with Option 20.
- m. Option 27 can only be ordered with either Options 12, 14 or 26 in any combination.
- n. Option 28 cannot be ordered along with either Options 12, 14, 26, or 27.
- o. Option 36 can only be ordered with either Option 3, 3X, or 3XA.



To receive a quote to purchase a product or order accessories visit our online ordering site: [www.ShopAnritsu.com](http://www.ShopAnritsu.com)

## Training at Anritsu

Anritsu has designed courses to help you stay up to date with technologies important to your job. For available training courses visit: [www.anritsu.com/training](http://www.anritsu.com/training)



### • United States

#### **Anritsu Company**

1155 East Collins Blvd., Suite 100,  
Richardson, TX 75081, U.S.A.  
Toll Free: 1-800-267-4878  
Phone: +1-972-644-1777  
Fax: +1-972-671-1877

### • Canada

#### **Anritsu Electronics Ltd.**

700 Silver Seven Road, Suite 120,  
Kanata, Ontario K2V 1C3, Canada  
Phone: +1-613-591-2003  
Fax: +1-613-591-1006

### • Brazil

#### **Anritsu Eletrônica Ltda.**

Praça Amadeu Amaral, 27 - 1 Andar  
01327-010 Paraiso, São Paulo, Brazil  
Phone: +55-11-3283-2511  
Fax: +55-11-3288-6940

### • Mexico

#### **Anritsu Company, S.A. de C.V.**

Av. Ejército Nacional No. 579 Piso 9, Col. Granada  
11520 México, D.F., México  
Phone: +52-55-1101-2370  
Fax: +52-55-5254-3147

### • United Kingdom

#### **Anritsu EMEA Ltd.**

200 Capability Green, Luton, Bedfordshire LU1 3LU,  
U.K.  
Phone: +44-1582-433280  
Fax: +44-1582-731303

### • France

#### **Anritsu S.A.**

12 Avenue du Québec,  
Bâtiment Iris 1-Silic 612,  
91140 VILLEBON SUR YVETTE, France  
Phone: +33-1-60-92-15-50  
Fax: +33-1-64-46-10-65

### • Germany

#### **Anritsu GmbH**

Nemetschek Haus, Konrad-Zuse-Platz 1  
81829 München, Germany  
Phone: +49-89-442308-0  
Fax: +49-89-442308-55

### • Italy

#### **Anritsu S.r.l.**

Via Elio Vittorini 129, 00144 Roma, Italy  
Phone: +39-06-509-9711  
Fax: +39-06-502-2425

### • Sweden

#### **Anritsu AB**

Borgafjordsgatan 13A, 164 40 KISTA, Sweden  
Phone: +46-8-534-707-00  
Fax: +46-8-534-707-30

### • Finland

#### **Anritsu Finland**

Teknobulevardi 3-5, 01530 Vantaa, Finland  
Phone: +358-20-741-8100  
Fax: +358-20-741-8111

### • Denmark

#### **Anritsu A/S (for Service Assurance)**

**Anritsu AB (for Test & Measurement)**  
Kay Fiskers Plads 9, DK-2300 Copenhagen S,  
Denmark  
Phone: +45-3691-5035  
Fax: +45-7211-2210

### • Russia

#### **Anritsu EMEA Ltd.**

#### **Representation Office in Russia**

Tverskaya str. 16/2, bld. 1, 7th floor.  
Russia, 125009, Moscow  
Phone: +7-495-363-1694  
Fax: +7-495-935-8962

### • United Arab Emirates

#### **Anritsu EMEA Ltd.**

#### **Dubai Liaison Office**

P O Box 500413 - Dubai Internet City  
Al Thuraya Building, Tower 1, Suite 701, 7th Floor  
Dubai, United Arab Emirates  
Phone: +971-4-3670352  
Fax: +971-4-3688460

### • Singapore

#### **Anritsu Pte. Ltd.**

60 Alexandra Terrace, #02-08, The Comtech  
(Lobby A)  
Singapore 118502  
Phone: +65-6282-2400  
Fax: +65-6282-2533

### • India

#### **Anritsu India Pvt. Ltd.**

2nd & 3rd Floor, #837/1, Binnamangla 1st Stage,  
Indiranagar, 100ft Road, Bangalore - 560038, India  
Phone: +91-80-4058-1300  
Fax: +91-80-4058-1301

### • P.R. China (Shanghai)

#### **Anritsu (China) Co., Ltd.**

Room 2701-2705, Tower A,  
New Caohejing International Business Center  
No. 391 Gui Ping Road Shanghai, 200233, P.R. China  
Phone: +86-21-6237-0898  
Fax: +86-21-6237-0899

### • Hong Kong

#### **Anritsu Company Ltd.**

Unit 1006-7, 10/F, Greenfield Tower,  
Concordia Plaza,  
No. 1 Science Museum Road, Tsim Sha Tsui East,  
Kowloon, Hong Kong  
Phone: +852-2301-4980  
Fax: +852-2301-3545

### • Japan

#### **Anritsu Corporation**

8-5, Tamura-cho, Atsugi-shi,  
Kanagawa, 243-0016 Japan  
Phone: +81-46-296-1221  
Fax: +81-46-296-1238

### • Korea

#### **Anritsu Corporation, Ltd.**

502, 5FL H-Square N B/D, 681  
Sampyeong-dong, Bundang-gu, Seongnam-si,  
Gyeonggi-do, 463-400 Korea  
Phone: +82-31-696-7750  
Fax: +82-31-696-7751

### • Australia

#### **Anritsu Pty Ltd.**

Unit 21/270 Ferntree Gully Road, Notting Hill  
Victoria, 3168, Australia  
Phone: +61-3-9558-8177  
Fax: +61-3-9558-8255

### • Taiwan

#### **Anritsu Company Inc.**

7F, No. 316, Sec. 1, Neihu Rd., Taipei 114, Taiwan  
Phone: +886-2-8751-1816  
Fax: +886-2-8751-1817

List Revision Date: 20130718



© Anritsu All trademarks are registered trademarks of their respective companies. Data subject to change without notice. For the most recent specifications visit: [www.anritsu.com](http://www.anritsu.com)  
Anritsu prints on recycled paper with vegetable soybean oil ink.

MG3690C Signal Generator TDS  
Copyright August 2013 Anritsu Company, USA  
All Rights Reserved



11410-00515



J