

RXT-3000 Combo Module

Multi-Service 1.5/2M to 11.1 Gbps



RXT-1200

Modular Test Platform

Advanced OTN, SDH/SONET, PDH/DSn, Ethernet, and Synchronous Packet Networks Test Set

The RXT-3000 Combo Module is a full featured test solution for OTN, SDH, SONET, PDH, DSn networks, and offers extensive support for Mobile Backhaul technologies with SyncE, 1588v2 PTP, Carrier Ethernet, Fibre Channel and CPRI/OBSAI testing.



Platform Highlights

- All-in-One test module reduces CAPEX
- Optimized for engineers or technicians installing and maintaining OTN, SDH/SONET, and Carrier Ethernet networks transporting legacy and next generation Mobile Backhaul networks
- Flexible software platform allows for multiple test applications running simultaneously
- User defined test profiles and thresholds

SyncE/IEEE 1588v2

- Fully integrated solution for synchronized packet networks
- Supports IEEE 1588v2/PTP and SyncE/ITU-T G.8261 standards
- Master Clock and Slave clock emulation
- IEEE 1588v2/PTP protocol monitoring and decoding
- IEEE 1588v2/PTP PDV analysis
- Clock recovery from SyncE or PTP and output to E1 or DS1 port
- ESMC SSM generation, monitoring and decoding

CPRI/OBSAI Testing

- Common Public Radio Interface standard (CPRI): supports all rates from 614.4 Mbps to 9.8304 Gbps
- Open Base Station Architecture Initiative (OBSAI): supports all rates from 768 Mbps to 6.144 Gbps
- Unframed, Layer 1 Framed and Layer 2 BER testing with PRBS stress patterns
- Latency measurements

OTN/SDH/PDH

- Optical SDH/SONET testing for STM-0/1/4/16/64 and OC1/3/12/48/192; including STM-0/1e (STS-1/3) electrical
- OTN testing for ODU0, ODU Flex, OTU1, OTU2, OTU1e/OTU2e
- PDH testing at E1, E2, E3, E4, DS1, DS3
- Non-intrusive Pulse Mask Analysis at E1, E3 and DS1, DS3 rates
- Automatic Protection Switching and Service Disruption
- Round Trip Delay on all interfaces and payload mappings
- Overhead Monitoring and Byte decoding
- Tandem Connection Monitoring
- Jitter/Wander Analysis (E1, E3, DS1, DS3 and STM-1o, OC-3)

Ethernet/Fibre Channel

- 10GE LAN/WAN XFP, 100Base-FX/1000Base-X SFP, 10/100/1000Base-T RJ45 ports
- 1G/2G/4G/8G/10G Fibre Channel support for Storage Area Networks
- RFC2544 Throughput, latency, frame loss and back to back tests
- V-SAM test suite compliant with ITU-T Y.1564 standard
- Q in Q (VLAN stacking), MPLS, MPLS-TP, PBB support
- IEEE 802.3ah, ITU-T Y.1731, IEEE 802.1ag, and MPLS-TP OAM support
- RFC6349 V-PERF TCP test suite

PDH/DSn Applications

PDH and T-Carrier (DSn) multiplexing and transmission systems developed in the 1960s and 1970s comprise the first generation of digital telecommunications network technology. While these networks have subsequently evolved to include long-distance, high-capacity trunks and OTN, SDH, SONET rings, PDH and DSn network segments are frequently retained for access, service delivery, and economic reasons. As such, testing PDH and T-Carrier networks will continue for several years to come.

The RXT-3000 Combo provides PDH and DSn test capabilities and sub-rates from 140 Mbps (E4), 34 Mbps (E3), 8 Mbps (E2), 2 Mbps, down to N/M × 64 kbps and 45 Mbps (DS3), 1.5 Mbps (DS1), down to N/M × 56 kbps. Additional test features include simultaneous multilayer G.821, G.826, M.2100 results, Pulse Mask analysis and Round Trip Delay. The test rates also supports mapping and de-mapping of E1, E3, and E4 payloads in virtual containers and testing of TU-11, TU-12, TU-3, and STS-1, making it ideal for testing hybrid PDH/SDH and DSn/SONET networks.

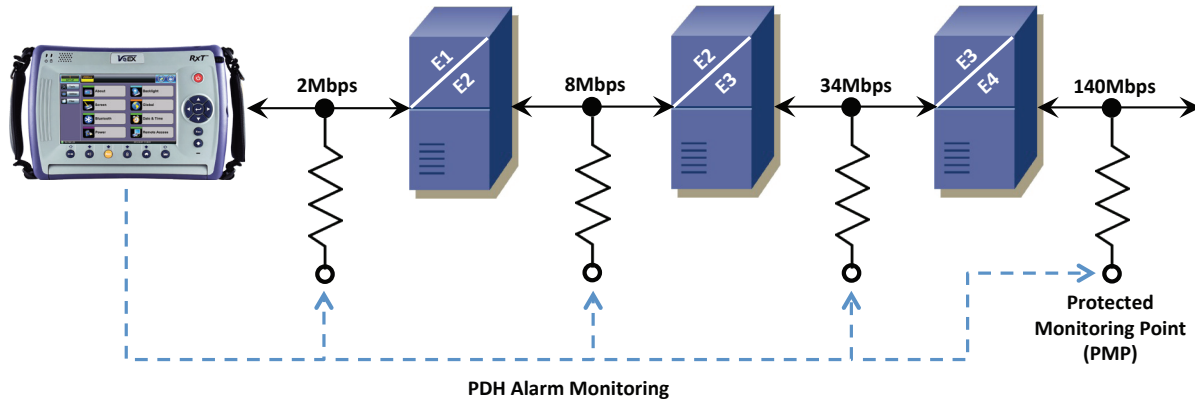

PDH/DSn Features

Auto Configuration

Auto configure simplifies instrument setup when properties of the incoming test signal are unknown. This feature allows novice users to start performing measurements quickly.

DS1 Multi-BERT™

Bring into service and troubleshoot DS1 links quickly by automatically generating different test patterns in a sequential BER test. Since certain test patterns can help identify and test for specific problems or behaviors, the test sequence can be customized with specific test patterns and timings to target specific test scenarios, like checking for proper line coding settings, framing, or clock recovery.

DS1 Loopback Commands

Enhanced DS1 Loopback commands enable users to single-handedly test DS1 links by activating automated loopbacks in the desired network elements.

Intuitive Test Results

A summary screen quickly reports signal status and critical Error and Alarm parameters with easy-to-read Pass/Fail indicators. Additional screens accessed via a simple tab system display signal levels, anomalies and events.

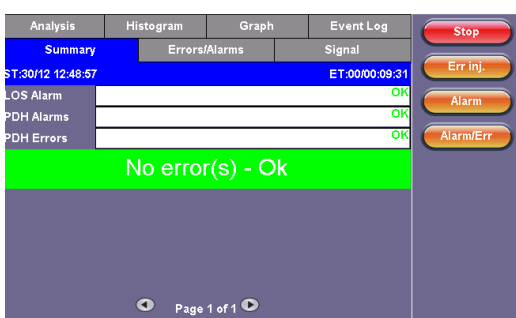

Powerful Measurement Histograms

Visual presentation of simultaneous measurement results with 1-second resolution simplifies correlation of alarms and errors.

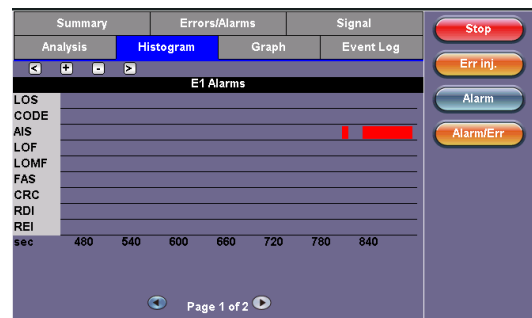

Pulse Mask Analysis

PDH/DSn signals may fail pulse mask requirements due to interference, excessive cable length, improper impedance, or poor transmitter design. In such cases, G.703 pulse mask compliance is very useful in diagnosing related problems.

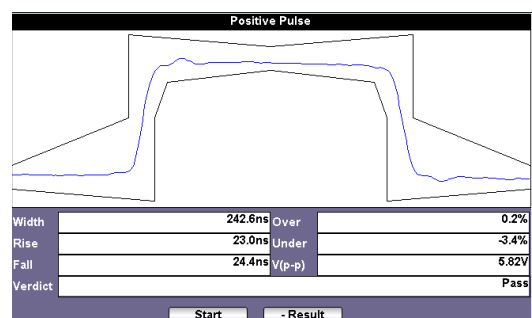

ISDN Testing

The ISDN option provides most of the functionality necessary for testing and troubleshooting DS1 or E1 Primary Rate connections like SIP trunking services. Operating in TE or NT modes, the unit is able to setup and receive ISDN calls with user-defined parameters including call control protocol, called number and related facilities.

Protocol functions feature detailed signaling statistics, message monitoring and decode, and complete result presentation. With these capabilities, analysis of international and national ISDN, and other access protocols is possible.

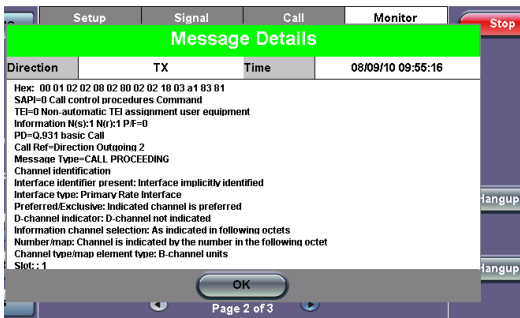

VF Testing

The Voice Frequency (VF) option is a basic diagnostic tool to install, verify and troubleshoot voice circuits. Digital to analog conversion tests are performed by inserting/measuring tones with user defined frequency and level on selected sub-rate channels.

A microphone/headset jack enables Talk/listen capability on a selected timeslot while a powerful function allows VF decoding at all PDH/DSn and SDH/SONET rates.

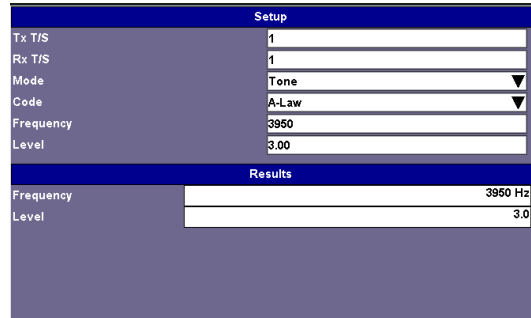

Jitter and Wander

Data integrity in synchronous networks depends largely on the phase stability of clock and data signals. Per the ITU-T G.810 recommendation, the term Jitter is employed when the frequency of the unwanted phase modulation is greater than 10 Hz. When the frequencies are less than 10 Hz, the unwanted modulation is referred to as Wander. In SDH/SONET networks there is a great potential for the accumulation of jitter to degrade network performance, thus it is imperative that components and the network as a whole be tested and screened regularly for jitter to ensure that optimum levels of quality can be maintained.

Jitter Metrics

Output jitter performance mandated by ITU-T 0.171/0.172 and Telcordia GR-499/253 standards is evaluated by measuring the recovered clock of the incoming signal (E1, E3, STM-1o and DS1, DS3, OC-3) traversing the network.

Specified in unit intervals (UI), the maximum Peak-to-Peak Jitter is the most important parameter because Max values are indicative of performance, as these extremes generally cause errors. While jitter is defined as any phase variations above 10 Hz, the incoming signal must be filtered in order to measure jitter – the user is therefore able to select between Wide band and High band filters to adjust the measurement bandwidth as required.

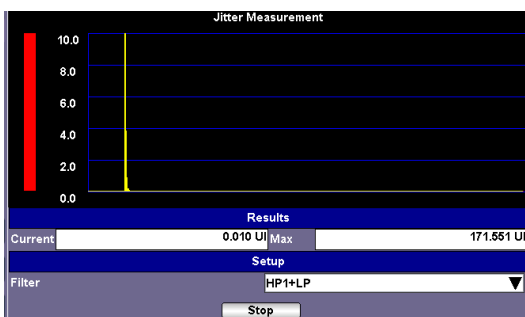

Wander Metrics

Wander is measured against an external reference clock whereas jitter is normally measured with reference to the clock extracted from the incoming data signal.

The wander external reference clock input accepts clock signals at 1.5 MHz and 2 MHz including signals with bit rates of 64 kbps, 1.544 Mbps and 2.048 Mbps.

Measuring the input signal (E1, E3, STM-1o and DS1, DS3, OC-3) with reference to the external clock signal, the time interval error (TIE) is derived. Unlike jitter results which are reported in Unit Intervals, TIE values are given as absolute time values (ns). MTIE (Maximum Time Interval Error) results report the largest peak-to-peak TIE observed during the measurement period.

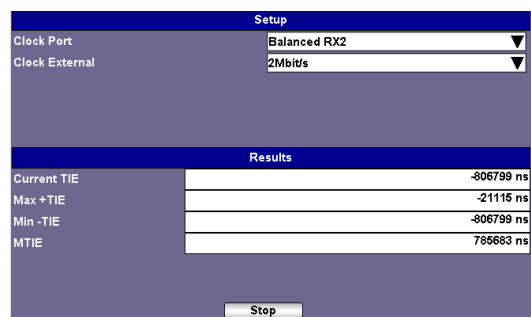

OTN Applications

Introduction

The OTN test application provides technicians and engineers with a comprehensive and powerful set of test functions required for installing, commissioning, and troubleshooting OTN networks. The optional OTN test suite can be easily activated using a license key and ReVeal RXTS software.

Bit Rates

The RXT-3000 Combo offers various software options to verify compliance to the ITU-T G.709 standard including extended (over clocked) bit rates to ITU-T series G supplement 43 standards. The following OTN test interfaces are available:

- SFP transceiver supports OTU1 (2.66 Gbps)
- XFP transceiver supports OTU2 (10.7 Gbps), OTU1e (11.049 Gbps) and OTU2e (11.095 Gbps)

Test Applications

Similar to SDH/SONET, OTN networks require both in-service and out-of-service tests to be performed. *In-service* testing involves monitoring an operational network for alarms and errors over a period of time while *out-of-service* testing is typically performed during the commissioning phase to ensure that a network is fully functional before transmitting live traffic.

The network element response test involves sending a stimulus (error or alarm) signal into the OTN Device Under Test (DUT) and monitoring its output and proper response. The response test must be repeated for all possible input stimuli that the DUT is expected to respond to.

OTN Features

Intuitive Test Signal Setup

Transmitting and receiving ITU-T G.709 compliant OTN signals is quick and simple. The transmitter and receiver can operate independently, or they can be coupled depending on test setup. Framed signals can be equipped with unstructured or structured payloads – a user-selected test pattern fills the entire payload (Bulk) or a structured payload (SDH/SONET framed client signal) is used. Scrambling and Forward Error Correction (FEC) can be enabled or disabled to verify applicable circuitry.

Advanced Mapping Capability

SDH/SONET client signals can be mapped using bit-synchronous or asynchronous modes. Synchronous means the Optical Payload Unit (OPU) clock is derived from the mapped client signal while Asynchronous means the OPU clock is independent. The mapping structure can be viewed and checked in the Signal summary tab.

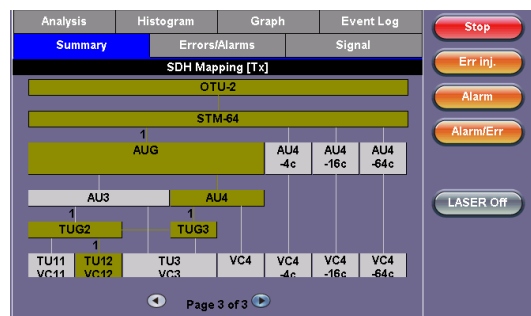
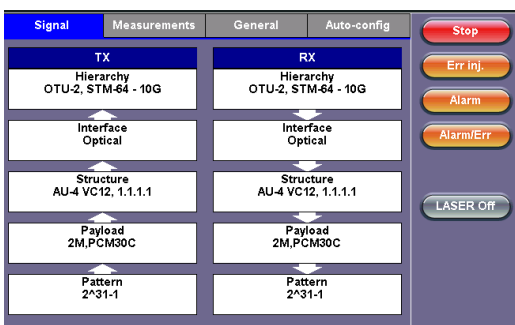

Error Insertion and Alarm Generation

Alarms and Errors can be applied to the OTN signal or to the payload itself. A full range of PDH/DSn and SDH/SONET anomalies and alarms are supported depending on payload setup. Single errors, preset rates or user-defined error rates are supported.

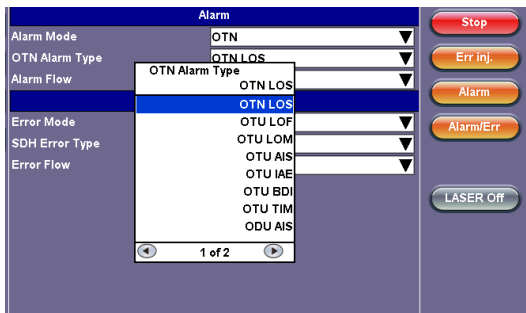

Line and Payload Frequency Analysis

Frequency offset present in the Optical Transport Unit (OTU) line frequency or Optical Payload Unit (OPU) are measured accurately. Furthermore, frequency offset applied to the signal by the user regardless of the clock source can also be analyzed.

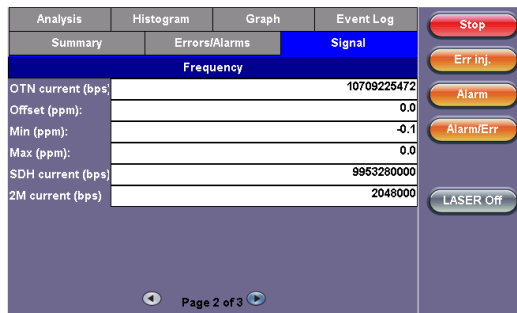

Monitoring Errors and Alarms

It is possible to monitor OTN anomalies and defects in the SDH/SONET payload signals. Similarly, bit errors are monitored when the OTN signal payload is a test signal. Soft LEDs display event status continuously while a test is running – errors and alarms are color coded to show present and historical conditions.

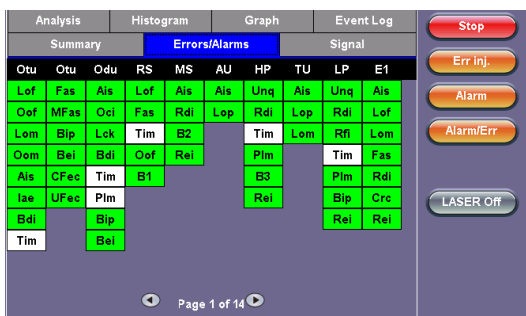

Overhead Byte Analysis

All overhead bytes in the OTU/ODU/OPU are captured and displayed in hexadecimal format. Direct access to overhead bytes ensures that the DUT performs termination and pass-through operations accurately.

Analysis																	
FAS						MF	SM			GCC0			RES	RES	JC		
OA1	OA1	OA1	OA2	OA2	OA2	72	TTI	BIP	BEI	TTI	BIP	BEI	TTI	BIP	BEI	00	00
F6	F6	F6	28	28	28		TI	9B	00	00	00	00	00	00	00	00	00
RES		TC	TCM6			TCM5			TCM4			FT	RES	JC			
00	00	00	00	00	00	TTI	BIP	BEI	TTI	BIP	BEI	TTI	BIP	BEI	FT	RES	JC
TCM3		TCM2			TCM1			PM			EXP	RES	JC				
TTI	BIP	BEI	TTI	BIP	BEI	TTI	BIP	BEI	TTI	BIP	BEI	RR	RR	RR	RR	00	00
TI	24	01	TI	24	01	TI	B8	01	TI	B8	00	00	00	00	00	PSI	NJO
GCC1		GCC2			APS/PCC			RES									
00	00	00	00	00	00	00	00	00	00	00	00	00	00	00	00	03	00

SDH/SONET Applications

Installation, commissioning, monitoring and maintenance of SDH/SONET and PDH/DSn networks is simplified thanks to a combination of intuitive features and powerful test functions. SDH signals are often compromised by various impairments in the multiplexing process therefore defining the type of anomaly or defect to isolate the network element or signal path causing the problem is crucial. Fast troubleshooting and comprehensive analysis of transmission problems can be performed using intrusive, non-intrusive and monitoring test modes. Novice users will benefit from the easy-to-use Auto-configuration and Tributary Scan test modes, while experienced users will appreciate the array of advanced features such as Overhead Monitoring and Byte Control, Pointer Test Sequences, Path Trace Generation, Tandem Connection Monitoring and lots more.

Out-of-Service Testing

- Applications include:
- BERT
 - Tributary Mapping/de-Mapping
 - Path/Section Trace Generation
 - Bringing Into Service (M.2100)
 - Pulse Mask Analysis (E1/E3/DS1/DS3)
 - Mux Testing
 - Round Trip Delay
 - Pointer Test Sequences
 - Jitter Generation, MTJ, JTF

In-Service Monitoring

- Applications include:
- Optical Power and Frequency
 - Tributary Scanning
 - Performance Analysis per G.826, G.828, G.829, M.2101
 - Pointer Analysis and Generation
 - APS Measurement
 - Tandem Connection Monitoring
 - Overhead Byte Control and Decode
 - Jitter and Wander Measurements

SDH/SONET Features

Quick and Easy Graphical Setup

Complex daily tasks are common in today's network environment, therefore technicians need a tester that is quick and easy to configure. Intuitive graphics, drop down menus and touch-screen operation greatly simplify test interface, signal structure, payload mapping and test pattern setup.

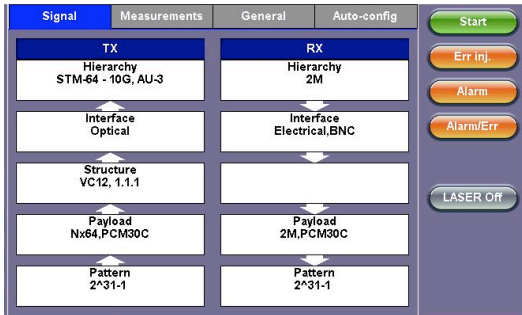

Physical Layer Testing

Verifying analog parameters are within prescribed specifications and limits is recommended prior to performing framing and payload analysis. High optical power levels can saturate receiver equipment, while low power levels are susceptible to noise which result in bit errors. Clock tolerances for each individual signal hierarchy is clearly defined by Bellcore/ITU-T recommendations and should be verified as part of any acceptance/conformance test.

Payload Mappings

Test the operation of Add/Drop Multiplexers, Digital Cross Connects and other Network Elements (NE) by verifying the mapping and de-mapping of different tributaries and payloads into SDH or SONET containers and monitor anomalies and defects according to ITU-T G.707 and GR-253 recommendations.

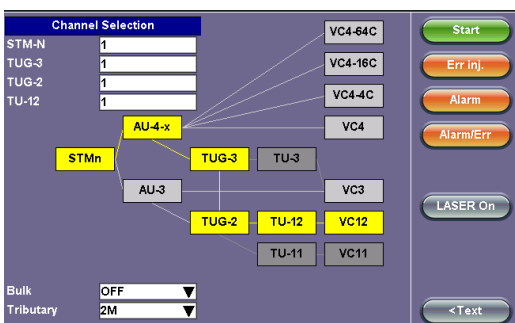

Performance Analysis Summary

Performance of each hierarchy is based on Byte Interleaved Parity (BIP) checksums which are calculated on a frame by frame basis. These BIP checks are inserted into the Regenerator, Multiplexer and Path Overhead, all of which form an integral part of the performance monitoring capabilities of an SDH/SONET network. The RXT-3000 Combo analysis screens present Pass/Fail criteria for each performance parameter according to ANSI/ITU-T recommendations.

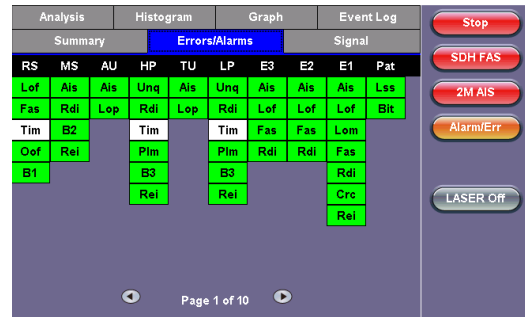

Overhead Analysis

Binary and hexadecimal decode of all Section and Path overhead bytes are performed.

SOH			POH			Summary	
A1 F6	A1 F6	A1 F6	A2 28	A2 28	A2 28	J0 01	AA AA
B1 00	--	--	E1 00	--	--	F1 00	--
D1 00	--	--	D2 00	--	--	D3 00	--
H1 6A	H1 93	H1 93	H2 0A	H2 FF	H2 FF	H3 00	H3 00
B2 30	B2 A4	B2 8A	K1 00	--	--	K2 00	--
D4 00	--	--	D5 00	--	--	D6 00	--
D7 00	--	--	D8 00	--	--	D9 00	--
D10 00	--	--	D11 00	--	--	D12 00	--
S1 00	Z1 00	Z1 00	Z2 00	Z2 00	M1 00	E2 00	--

Overhead Byte Control

Manipulation of transmitted overhead bytes in both terminated and payload through modes enable users to stress the network responses to various conditions.

Synchronous Network Features

IEEE 1588v2/PTP Master Clock Emulation Mode

Master Clock emulation allows network synchronization properties to be verified prior to service delivery or during routine maintenance tasks. Using the internal precision clock or an external 1.544 Mbps, 2.048 Mbps, 1.544 MHz, 2.048 MHz, 10 MHz, 25 MHz, 125 MHz, or 1 PPS signal as the reference clock, the unit generates the PTP messages needed by a Slave device to synchronize.

The reference clock can further be applied to an outgoing 1.544 Mbps or 2.048 Mbps signal via balanced RJ45 or bantam interfaces or alternatively a 1.544 Mbps, 2.048 Mbps, 10 MHz, 25 MHz, 125 MHz, or 1 PPS signal can be generated on the unbalanced BNC port for other synchronization requirements. In this mode, the unit can be programmed to generate PTP messages at different rates to reduce or introduce network congestion.

IEEE 1588v2/PTP Slave Clock Emulation Mode

Emulates a Slave Clock device where synchronized clock is extracted using the PTP procedure. The extracted clock can be applied to an outgoing 1.544 Mbps or 2.048 Mbps signal on the DS1/E1 balanced test port or a 1.544 Mbps, 2.048 Mbps, 10 MHz, 25 MHz, 125 MHz, or 1 PPS reference signal can be made available on the unbalanced BNC port. After an IP layer connection is achieved, clock identities are exchanged between the test unit and the far end Master clock device. The PTP messages can be monitored and decoded.

In the Summary tab, an overview of the Total, CRC, lost, error, out of order and duplicated messages are displayed. The Message tab provides a concise record of all PTP message related items, while the Results tab provides detailed statistics and values for Packet Delay Variation (PDV), Round Trip Delay (RTD) and Inter-Packet Gap (IPG). Clock and Wander are measured against the reference clock.

ITU-T G.8261 SyncE Master Clock Emulation Mode

The reference clock can be based on the internal precision clock or from an external clock source at 1.544 Mbps, 2.048 Mbps, 1.544 MHz, 2.048 MHz, 10 MHz, 25 MHz, 125 MHz, or 1 PPS rate. The output reference clock can be synchronized to 1.544 Mbps or 2.048 Mbps and provided at the DS1/E1 port or a 1.544 MHz, 2.048 MHz, 10 MHz, and 1 PPS clock signal can be made available on the unbalanced BNC port.

ITU-T G.8261 SyncE Slave Clock Emulation Mode

Extracts clock information from the incoming Ethernet signal at the 10/100/1000Base-T, 100Base-FX, 1000Base-X, and 10GBase-X interface. The recovered reference clock can be applied to a 1.544 Mbps or 2.048 Mbps signal at the DS1/E1 port or a 1.544 MHz, 2.048 MHz, 10 MHz, 25 MHz, 125 MHz, or 1 PPS clock signal can be made available on the unbalanced BNC port. Clock and Wander are measured against the reference clock.

Synchronization Messages Capture

Message capture and decode for SyncE ESMC/SSM and IEEE 1588v2 messages.

ESMC SSM

ESMC SSM messages generation with configurable type and rate. Includes ESMC SSM messages display and decode, with capture function in pcap format for external analysis.

Clock Wander & Phase Measurements

This option compares two clock sources and measures TIE (wander) or Timing Error (absolute phase error) differences between the signal present at the RX1 (BNC) test port and the external reference connected to the CLK (SMA) port or the optional internal GPS and Atomic clocks. Reports current, minimum, maximum and average phase differences Phase Error vs. Time graph (last 600s)

Wander Resolution: 0.2 ns

Phase Error Resolution: 1 ns

Phase Accuracy: ± 6.4 ns

Real-time Wander & Phase Data Logging

Exports real-time TIE or Phase measurements to a USB memory for further post-processing using the built-in or PC-based MTIE & TDEV Wander Analysis applications.

Modes: E1, E3, DS1, SyncE, IEEE 1588v2, external clock signals

Sampling rates: 1/s, 5/s, 10/s, and 30/s

File formats

- VeEX's native TIE and Phase
- Open CSV TIE and Phase

Built-in MTIE/TDEV Wander Analysis

This option enables the RXT-3000 Combo to analyze up to two days worth of wander measurement data and compare it against standard masks for a PASS/FAIL assessment, without the need for a PC. The analysis can be performed while the test is still running for run-time verification.

- Provides further post-processing of clock stability data, such as MTIE and TDEV
- Frequency offset calculation and removal for relative TIE analysis
- Standard MTIE and TDEV masks
- MTIE and TDEV results and mask export to CSV
- Direct PDF report generation to USB



Ethernet Key Features

RFC2544 Compliance Testing

Performs the RFC2544 automated test suite at all recommended frame sizes as well as user configurable frame sizes and up to full line rate. The test suite can be performed with the far end test partner in loopback mode or peer-to-peer mode - the latter allowing for symmetrical/asymmetrical testing. Thresholds may be configured for accurate SLA assurance and verification. The automated tests supported are throughput, latency, frame loss, and back-to-back frames.

In Advanced SLA Mode this feature combines the powerful multiservice throughput test capabilities with the RFC2544 industry test suite for SLA verification. Using this test function, service providers are able to verify SLAs while end-to-end QoS is assessed properly. By configuring one primary test stream and up to seven background streams each with independent frame size, bandwidth, and more importantly QoS levels, simulating different service applications is now realized. The Advanced RFC2544 SLA mode provides detailed visibility of the test parameters for each of the traffic streams being measured, providing an efficient in-depth qualification in a fast and automated way.

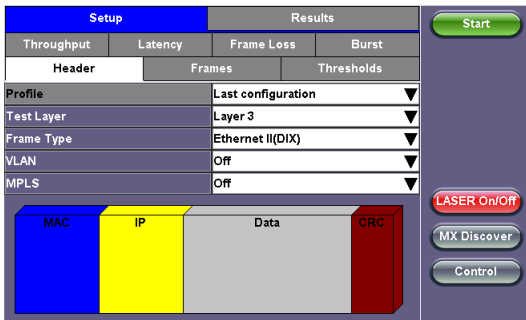

Multiple Streams Generation - Throughput

Up to ten traffic streams can be independently configured with CoS (VLAN priority) and QoS (TOS/DSCP) prioritization. This traffic feature simulates multiple service conditions (e.g. Triple Play), and facilitates end-to-end QoS performance verification. The multiple stream throughput tests may be performed with a second test unit at the far end in Smart Loop mode or Peer-to-Peer mode.

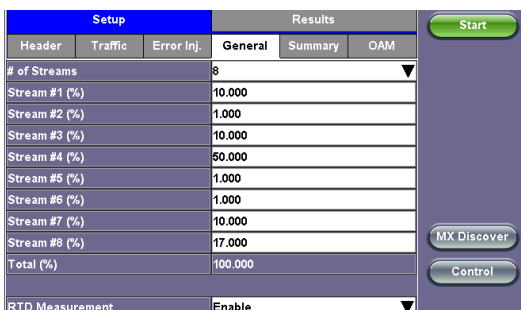

BERT

Layer 1 unframed (optical ports only), Layer 1 (framed), 2, 3, and Layer 4 BER testing are supported. The BER test can be configured to use regular PRBS test patterns, IEEE stress patterns for 1GE and 10GE LAN unframed modes, or user defined test patterns to simulate various conditions.

Protocol Support

With intuitive graphical based user interface, users can fully customize test traffic at the Layer 2 (MAC header), Layer 3 (IPv4 and IPv6 headers) and Layer 4 (TCP,UDP). The RXT-3000 Combo also offers a complete tool set of advanced network protocols.

Q-in-Q (VLAN stacking)

VLAN stacking, also known as Q-in-Q, makes a provision for carrier/service provider assigned VLANs (SP-VLAN), but also retains customer traffic's VLAN (CE-VLAN). Up to three layers of VLAN tagging supported with configurable VLAN ID, Priority, and VLAN type.

Multiprotocol Label Switching (MPLS)

MPLS technology allows for a more efficient routing of Ethernet/IP packets via the use of MPLS routers in the network. MPLS labels reside between the MAC (Layer 2) and IP layers (Layer 3). Up to three MPLS tags can be configured in the traffic stream with customizable Label, CoS, and TTL fields.

Provider Backbone Bridging (PBB)

Also known as MAC-in-MAC, PBB (802.1ah) provides a trunking mechanism that adds resiliency and configurable performance levels in the provider backbone network. PBB encapsulation is available for all Ethernet tests with all PBB fields configurable.

Multiprotocol Label Switching Transport Profile (MPLS-TP)

MPLS-TP, a Layer 2 packet-based transport mechanism, is gaining momentum as a transport of choice for access and aggregation networks requiring a technology that combines the operational simplicity of packet switched networks with the operations, administration and maintenance (OAM) tools and fault resiliency capabilities of Circuit switched networks. Fully configurable MPLS-TP header fields including LSP and Pseudowire MPLS-TP support for all Ethernet tests along with MPLS-TP OAM per ITU-T G.8113.1.

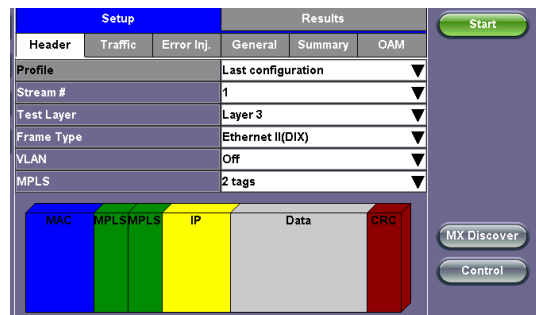

Ethernet *cont'd*

Y.1564 V-SAM Test

VeEX's V-SAM test suite is fully compliant with ITU-T Y.1564 and offers an efficient method to qualify and troubleshoot Ethernet Services. V-SAM addresses some of RFC2544 limitations by testing multiple services at once and providing simultaneous measurements of key SLA parameters.

With the Service Configuration test, services running on the same line are tested one by one to verify the correct service profile provisioning. With the Service Performance test, the services running on the same line are tested simultaneously over an extended period of time, to verify network robustness.

This test suite was designed with the end user in mind and allows for quick provisioning, execution and analysis of the test results, even without prior detailed knowledge of the standard.

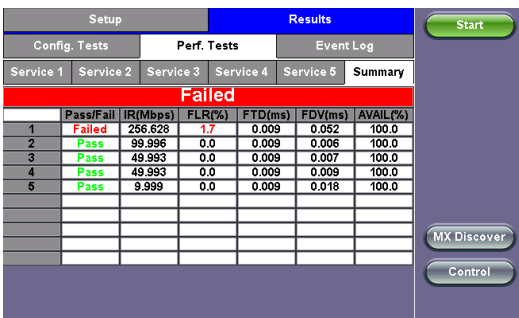
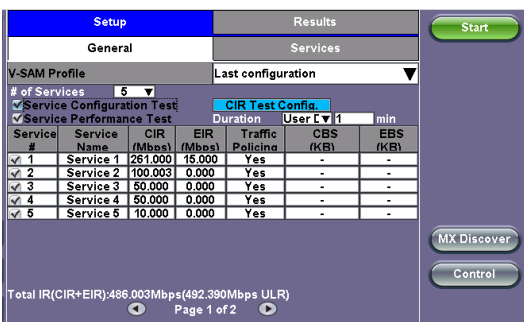

Ethernet OAM Features

The RXT-3000 Combo offers a complete tool set for Link Level (IEEE 802.3ah) and Service Level (IEEE 802.1ag/ ITU- Y.1731) OAM for monitoring and maintaining carrier grade Ethernet services as well as OAM support for MPLS-TP per ITU-T G.8113.1 including G-ACH and GAL labels support per RFC 4385 and RFC 5586.

Link Fault Management testing with 802.3ah OAM, capabilities include:

- Discovery mechanism to verify capabilities and provisioning of link partner
- Remote Loopback command for link performance testing
- Critical Link Event Notification

Connectivity Fault Management testing with 802.1ag and Y.1731, capabilities include:

- Linktrace message to perform path discovery
- Loopback message to test connectivity and isolate faults
- Continuity check messages to detect connectivity issues

Performance Management testing with Y.1731, capabilities include:

- Frame Loss Measurement (ETH-LM) function for service frame loss ratio measurement
- Delay Measurement (ETH-DM) function for frame delay and frame delay variation measurement

Intelligent Network/Device Discovery

Easily discover and select another VeEX Ethernet tester or loopback device on the network under test. The local device will control the operation of the far end device, in either loopback or peer-to-peer mode (symmetrical or asymmetrical traffic generation mode). This feature greatly simplifies field testing since there is no need for a second technician to be at the far end configuring the test partner device.



Smart Loopbacks

Four modes are available for looping back test traffic. At Layer 1, all incoming traffic is looped back unaltered. At Layer 2, all incoming unicast traffic is looped back with the MAC source and destination addresses swapped. At Layer 3, all incoming unicast traffic is looped back with the MAC and IP source and destination addresses swapped, and at Layer 4, all incoming unicast traffic is looped back with the MAC, IP, and UDP/TCP ports swapped.

Configurable traffic filters are supported on all MAC, IP, and VLAN fields to allow full control over looped traffic. Traffic is monitored while being looped and key traffic metrics such as frame type, rate, and error/alarms are displayed on screen. These can be compared to results at the far end to pinpoint issues more easily.

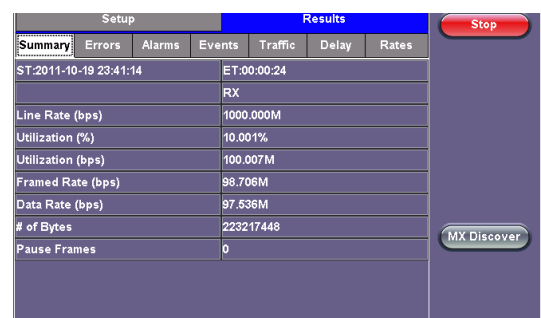

Ethernet *cont'd*

RFC6349 V-PERF TCP Test

A common source of customer complaints come from file transfer speeds not matching the throughput rates guaranteed in the SLA. While many factors affect TCP applications performance, including customer’s operating system hardware performance and settings (TCP window size), carriers need to prove SLA with a test tool that can show TCP performance independent of Operating System or Server limitations and present repeatable reliable results.

The RXT-3000 Combo V-PERF feature uses RFC6349 test methodology and metrics for qualifying network TCP performance. It offers a full line rate stateful TCP test with configurable window sizes, client and server modes as well as compatibility with iPerf servers.

FTP Throughput and VeTest HTTP Throughput Test

FTP Throughput and VeTest features provide additional Layer 4-7 testing. The FTP Throughput feature allows the user to test up to full line rate FTP protocol performance to any FTP Server by uploading and downloading files. The VeTest feature qualifies network HTTP protocol performance by downloading and uploading files to a VeTest HTTP server. Both features can test up to the full line depending on the server specifications and limitations. Connection time to the server, data transfer time, line rate throughput rates, and protocol (FTP and HTTP) throughput rates key metrics are reported during the tests.

VLAN Scan and Traffic Monitor

VLAN Scan allows scanning up to 4096 VLAN IDs for switch configuration verification. Verify which VLAN IDs are the top bandwidth users and monitor up to eight live traffic streams (in terminate mode).

Setup	Results	
Scan	Monitor	Stop
Vlan ID	Vlan Stack	
VLAN ID	RX(%)	
66	16.660	
67	16.660	
64	16.660	
65	16.660	
68	16.660	
69	16.660	

Page 1 of 1

MX Discover

Delay Measurements

In addition to round trip delay measurements, the RXT-3000 Combo provides advanced one-way delay measurement capabilities. With GPS option one-way delay can be measured between remote test sets. The delay measurements are provided for each independent traffic stream.

Wireshark™ Packet Capture

Live packet capture with Wireshark decode interface. This function captures packets from the Ethernet test ports and provides packet and protocol summaries and Hexadecimal displays. The captures can be saved in standard PCAP format and exported for analysis.

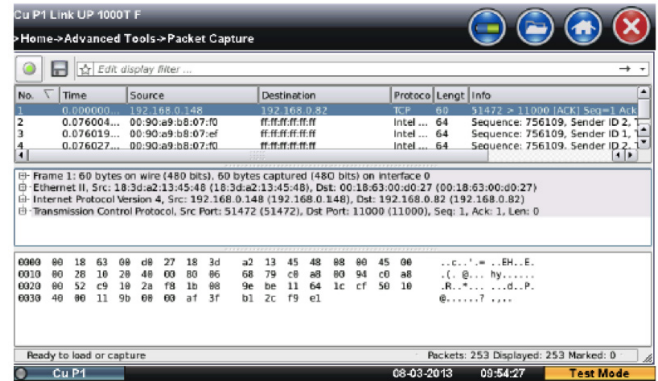

Fibre Channel Key Features

Key Features

- SFP optical port supporting 1.0625 Gbps, 2.125 Gbps, and 4.25 Gbps
- XFP optical port supporting 8.5 Gbps and 10.52 Gbps
- Full line rate traffic generation and analysis
- Primitive Sequence Protocol support
- Flow control support with Buffer-to-Buffer credits
- FC-1 and FC-2 BERT and Throughput
- RFC2544: Throughput, Latency, Frame Loss, and Back-to-Back frames tests
- FC-2 Smart Loop mode
- Service Disruption Measurement
- FC-2 Frame Header configuration
- Test traffic shaping: constant, ramp, and burst
- Frame Length configuration up to 2148 bytes

Throughput and Bit Error Rate Test (BERT)

The Fibre Channel protocol specifies a maximum allowable Bit Error Rate (BER) of $\leq 1 \times 10^{-12}$ that must be achieved. The RXT-3000-Combo allows the user to stress FC-1 and FC-2 network layers to ensure accurate benchmarking.

For FC-1, frequency fluctuations, transceiver noise and phase jumps are tested using CRPAT, CSPAT, and CJPAT patterns. Data dependency and behavior of network components are checked with PRBS patterns, sequence number tracking, and time stamping to calculate frame loss, round trip delay, and other performance metrics.

RFC2544 Benchmarking

Based on the Ethernet test methodology, the RFC2544 routine has been adapted to Fiber Channel circuits where flow-control and buffer verification is important. The feature checks throughput and round trip delay at various buffer sizes to verify optimal buffer size and best possible link performance.

CPRI & OBSAI Testing

Traditional deployment of the base station functions are co-located with the radio tower at the base of the antenna or basement of a tall building.

The Common Public Radio Interface (CPRI) and Open Base Station Architecture Initiative (OBSAI) protocols introduce a centralized model where one REC (Radio Equipment Controller) can manage many REs (Radio Equipment). The REC can be physically located far from radio towers in a centralized indoor and temperature controlled location. The CPRI/OBSAI optical link between REC and RE allows long distances (up to 10 km) without loss.

Simplified RE function makes field elements more compact, easier to install, and therefore increases the number of possible sites. Further Capex and Opex improvements are possible by having one REC manage many towers, and increased deployment flexibility to add new cell sites.

BERT

Test network performance with Layer 2, Layer 1 Framed and Unframed BERT with PRBS stress pattern. Verify BER, code violations, alarms and service disruption testing. CPRI Layer 2 test includes control words decode and frame capture capabilities to troubleshoot interoperability or RF performance issues.

Latency Measurement

Highly accurate latency measurements ensures that CPRI traffic between controller and the radio equipment stays below standard specifications.

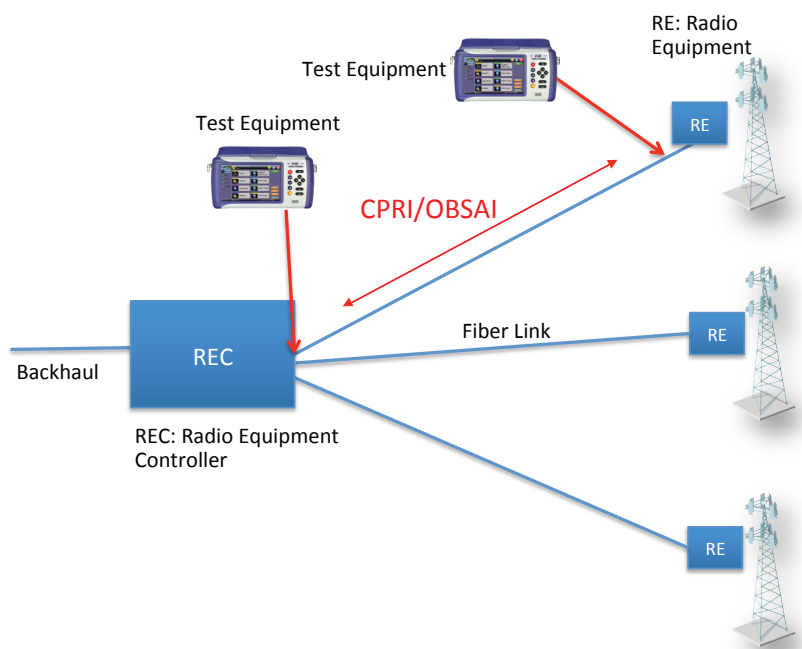

OTN/SDH/SONET/PDH/DSn Specifications

Key Features

- Flexible wavelength and bit rate options using industry standard SFPs and XFPs
- XFP optical port supporting OTU2, OTU2e, OTU1e, STM-64, OC-192 bit rates
- SFP optical port supporting OTU1, STM-16/4/1/0 and OC-48/12/3/1 bit rates
- Unbalanced port (BNC) for E1, E3, E4, DS1, DS3, STS-1, STM-0e and STM-1e
- Balanced port (RJ48 or Bantam) for E1 and DS1
- EoOTN Testing with OTU1e, OTU2e, ODU0 and ODUflex with Ethernet payloads
- Coupled or independent Tx and Rx settings
- Tandem Connection Monitoring
- Service disruption testing (SDT) and APS
- Round trip delay on all interfaces and payload mappings
- Jitter/Wander Analysis (E1, E3, DS1, DS3 and STM-1o, OC-3)

Test Setup

Test configuration, menus, and results are presented in VeEX's intuitive GUI, requiring little or no training for new or existing VePAL™ users, maintaining a consistent user experience from the lab to the field.

Layer-based graphical configuration interface allow users to build the test signal in a logical layer by layer sequence

- OTN/SDH/SONET/PDH/DSn interface selection
- Optical or Electrical signal settings
- Mapping and Multiplexing
- Payload (Bulk, multiplexed, or Ethernet)
- Test Pattern (CBR) or Traffic (Packets)

TX Clock Source

Internal: ± 3.5 ppm stability per ITU-T G.812

Recovered: from the incoming signal

External reference via Ext Clk (SMA) connector

- 1.544 MHz, 2.048 MHz, 1.544 Mbps, 2.048 Mbps

High-stability 1PPS Sources

- Built-in GPS Clock option
- Built-in Atomic Clock option

Tx Frequency Offset: Up to 50 ppm (25,000 ppm for E1) in steps of 0.1 ppm for both optical and electrical interfaces

Clock recovery (pulling range) per ITU-T G.703

Measurement Clock Reference

Internal: ± 3.5 ppm stability per ITU-T G.812

External Clock Input

- Unbalanced 75Ω SMA
- 1.544 MHz, 2.048 MHz, 1.544 Mbps, 2.048 Mbps

High-stability 1PPS References

- Built-in GPS Clock option
- Built-in Atomic Clock option

Optical Interfaces*

SFP and XFP transceivers conforming to Multi Source Agreement (MSA) specifications

Compliant to ITU-T G.957/G.691 Optical interfaces and systems relating to SDH

Optical Power Measurement: ± 2 dB accuracy, 1 dB resolution

Safety: Class 1, per FDA/CDRH, EN (IEC) 60825 eye safety regulations

Operating temperature range: -10°C to 70°C

ROHS compliant and Lead Free per Directive 2002/95/EC

OTN Functions

Key Features

- OTU2 (10.7 Gbps) and OTU1 (2.7 Gbps)
- OTU1e (11.049 Gbps) and OTU2e (11.095 Gbps) over-clocked bit rates
- EoOTN testing - internally generated Ethernet payload mapped into OTU1e, OTU2e, ODU0 or ODUflex
- Synchronous and asynchronous mapping of SONET/SDH signals, including multiplexed PDH/DSn payloads
- OTU, ODU, OPU overhead manipulation and monitoring
- OTU, ODU, OPU layer alarms/errors generation and analysis
- OTU, ODU, TCMi trace messages
- Forward error correction (FEC) testing
- Tandem Connection Monitoring
- Service Disruption Time measurement and Events tracking
- Frequency offset generation

OTN Interfaces

Standards: ITU-T G.709, ITU-T G.798, ITU-T G.872

Test rates

- OTU2 (10.7 Gbps) Framed
- OTU1 (2.7 Gbps) Framed
- OTU1e (11.049 Gbps), OTU2e (11.095 Gbps)

OTN Payloads

- ODU2-Bulk (test pattern)
- ODU2-STM-64 or OC-192, synchronous and asynchronous, including all supported mappings and multiplexed tributaries, down to E1/DS1 (Nx64/Nx56k)
- ODU1-Bulk (test pattern)
- ODU1-STM-16 or OC-48, synchronous and asynchronous, including all supported mappings and multiplexed tributaries, down to E1/DS1 (Nx64/Nx56k)
- ODU2e-Bulk and 10GE payloads
- ODU1e-Bulk and 10GE payloads
- ODU0-Bulk and 1GE payloads
- ODUflex with Nx1.25G Ethernet payloads

OTU Layer

Alarm and Error Monitoring

- Alarms: LOF, OOF, LOM, OOM, OTU-AIS, OTU-IAE, OTU-BDI, OTU-BIAE, OTU-TIM
- Errors: OTU-FAS, OTU-MFAS, OTU-BIP, OTU-BEI, Correctable FEC, Uncorrectable FEC

ODU Layer

Alarm and Error Monitoring

- Alarms: ODU-AIS, ODU-OCI, ODU-LCK, ODU-BDI, ODU-TIM
- Errors: ODU-BIP-8, ODU-BEI

OPU Layer

Payload Type (PT): Generates and displays received PT value

Expected Payload label setting

Enable/Disable PLM monitoring

Alarm and Error Monitoring

- Alarms: OPU-PLM

BER Test

Alarm and Error Monitoring

- Alarms: LSS (Loss Sequence Synchronization)
- Errors: Bit (Test Sequence Error)

Test Patterns

The following test sequences can be generated to fill the payload

- PRBS: $2^{31}-1$, $2^{23}-1$, $2^{20}-1$, $2^{15}-1$, $2^{11}-1$, 2^9-1 , 2^7-1 , QRSS
- Fixed: 0000, 1111, 1010, 1100, 1in8, 2in8, 3in24, DALY, NET55 and OCT55
- User defined: Ten 32-bit and one 24-Bit Programmable sequences

The following test sequences can be generated in Bulk mode

- PRBS: $2^{31}-1$, $2^{23}-1$

Error Insertion

OTN

- OTU-FAS, OTU-MFAS, OTU-BIP, OTU-BEI, Correctable FEC, Uncorrectable FEC, ODU-BIP, PM-BEI

Payload

- Bit (Pattern)

Injection Modes

- Single, Count (# of errors), Fixed Rates (1E-9 to 1E-3)

Alarm Generation

Physical Layer

- LOS

OTN

- OTU-LOF, OTU-LOM, OTU-AIS, OTU-IAE, OTU-BDI, OTU-BIAE, OTU-TIM, ODU-AIS, ODU-OCI, ODU-LCK, ODU-BDI, ODU-TIM, OPU-PLM

Generation Modes

- Continuous (manual), Count (0.1, 1, 10, 100 seconds)

OTN Overhead Analysis and Generation

Analysis – Decode and Display

Byte Decoding

- On-screen Decode
- OTUk bytes in hexadecimal, binary or ASCII formats
- SM-TTI (SAPI, DAPI, User), SM-BIP, SM-BEI/BIAE, SM-BDI, SM-IAE
- GCC0 bytes

ODUK bytes in hexadecimal, binary or ASCII formats

- DMp and DMti
- PM-TTI (SAPI, DAPI, User), PM-BIP, PM-BEI, PM-BDI, PM-STAT
- ODU-TCM-ACT, TCMi-TTI (SAPI, DAPI, User), TCMi-BIP, TCMi-BEI/BIAE, TCMi-BDI, TCMi-STAT
- GCC1, GCC2 bytes
- PCC/APS bytes

OPUk bytes in hexadecimal and binary formats

- JC1, JC2, JC3, (JC4, JC5, JC6), PSI, NJO

Reserved bytes

Generation - Programmable Bytes and sequences

OTU and ODU Trace Generation

- SAPI (15 characters)
- DAPI (15 characters)
- User (31 characters)
- Copy from received trace

TCMi Trace Generation

- SAPI (15 characters)
- DAPI (15 characters)
- User (31 characters)
- Copy from received trace

Set TCMi Status

- ODU-TCM-ACT (Binary and Hex)

Programmable Expected Traces

- OTU and ODU SAPI, DAPI, and User
- Copy from received trace
- Enable/Disable TIM monitor

Tandem Connection Monitoring (TCM)

TCMi Monitoring (1 through 6)

- LTC, AIS, OCI, LCK, BDI, BIAE, IAE; count
- IEC, BEI; count and rate

Trace Identifier Monitoring and Generation

- Programmable SAPI, DAPI and User traces
- Copy trace from RX
- Enable/Disable TIM monitoring

Ethernet over OTN (EoOTN)

Optional Mappings

- Direct mapping of 10G Ethernet payload into OTU1e or OTU2e, synchronous or asynchronous
- Direct mapping of 1G Ethernet payload into ODU0
- Direct mapping of Nx1.25G Ethernet payload into ODUflex

Ethernet Payload

- Layer 1 Unframed or Framed
- Layer 2, 3 and 4
- VLAN: Up to 3 tags
- MPLS: Up to 3 tags
- Layer 4: TCP or UDP

Ethernet Layer Testing*

- BERT
- RFC2544
- Throughput

Test Patterns (payload)

- PRBS: $2^{11}-1$, $2^{15}-1$, $2^{23}-1$, $2^{31}-1$
- Fixed: All 1s and All 0s
- User-defined 32 bit sequence
- Normal or Inverted

*Refer to the Ethernet Testing section for more details on Ethernet layer tests.

SDH/SONET Functions

SDH/SONET signals can be used as physical layer or as OTN payloads, and can contain multiplexed PDH/DSn clients, providing all the flexibility to address complex test scenarios

Key Features

- STM-64/16/4/1/0
- OC-192/48/12/3 and STS-1
- Bulk VC/STS/VT, PDH/DSn and multiplexed payloads
- Overhead manipulation and monitoring
- Alarms/errors generation and analysis
- Service Disruption Time (SDT) and APS
- Round Trip Delay
- Tributary Scan
- Tandem Connection Monitoring
- Pointer Test Sequences

SDH/SONET Interfaces

Optical

SFP

- STM-0/OC-1, 51.840 Mbps, NRZ
 - STM-1/OC-3, 155.520 Mbps, NRZ
 - STM-4/OC-12, 622.080 Mbps, NRZ
 - STM-16/OC-48, 2,488.320 Mbps, NRZ
- XFP
- STM-64/OC192, 9,953.280 Mbps, NRZ

Electrical

BNC (75Ω unbalanced)

- STS-1/STM-0e, 51.84 Mbps, B3ZS
- STS-3/STM-1e, 155.520 Mbps, CMI

Receiver Sensitivity

51.840 Mbps (STS-1/STM-0e)

- Terminate: ≤ 10 dB (cable loss only)
 - Monitor (PMP): ≤ 26 dB (20 dB resistive, 6 dB cable loss)
- 155.520 Mbps (STM-1e)
- Terminate: ≤ 12.7 dB (coaxial cable loss only)

Operating Modes**Normal (terminal)**

- The instrument terminates the line, serving as source and sink for the generated traffic
- Offers full access to Overhead and Payload alarms and error generation and monitoring

Payload Through (intrusive)

- Instrument retransmits the received Payload and allows access to Overhead manipulation
- Offers access to Overhead alarms and error generation as well as Payload monitoring

Line Through (transparent)

- Instrument regenerates and retransmits the entire received signal
- Offers minimal interaction with the test signal
- Provides full access to Overhead and Payload alarms and error monitoring

SDH Mappings

(According to ITU-T G.707)

- C-11 (Bulk/PRBS, unframed or framed DS1)
- C-12 (Bulk/PRBS, unframed or framed E1, asynchronous, bit or byte synchronous)
- C-3 (Bulk/PRBS, unframed, framed or channelized E3 or DS3) via AU-3 or AU-4
- C-4 (Bulk/PRBS, unframed or framed E4)
- C-4-4c (Bulk/PRBS)
- C-4-16c (Bulk/PRBS)
- C-4-64c (Bulk/PRBS)

SONET Mappings

(According to Telcordia GR-253/ANSI T1.105)

- VT-2 (unstructured or framed E1)
- VT-1.5 (unstructured or framed DS1, asynchronous or float byte synchronous)
- STS-1 SPE (unstructured or framed E3 or DS3)
- STS-3c SPE (unstructured or framed E4)
- STS-12c SPE (Bulk) STS-48c SPE (Bulk)
- STS-192c SPE (Bulk)

Test Patterns

The following test patterns can be generated

- PRBS: $2^{31}-1$, $2^{23}-1$, $2^{20}-1$, $2^{15}-1$, $2^{11}-1$, 2^9-1 , 2^7-1 , QRSS
- Fixed: 0000, 1111, 1010, 1100, 1in8, 2in8, 3in24, DALY, NET55 and OCT55
- User defined: Ten 32-bit and one 24-Bit Programmable sequences
- Mode : Normal or Inverted

Errors**Insertion**

- SDH: FAS, B1, B2, MS-REI, B3, HP-REI, LP-REI, LP-BIP, and bit errors
- SONET: FAS, B1, B2, REI-L, B3, REI-P, REI-V, BIP-V, and bit errors
- Modes: Single, Count (# of errors), Fixed Rates (1E-9 to 1E-3)

Detection

- SDH: FAS, B1, B2, MS-REI, B3, HP-REI, LP-BIP, LP-REI, slips and bit errors
- SONET: FAS, B1, B2, REI-L, B3, REI-P, REI-V, BIP-V, slips and bit errors

Alarms**Generation**

- SDH: LOS, LOF, MS-AIS, MS-RDI, RS-TIM, AU-LOP, AU-AIS, HP-UNEQ, HP-PLM, HP-RDI, HP-TIM, TU-LOM, TU-LOP, TU-AIS, LP-UNEQ, LP-PLM, LP-RDI, LP-RFI, LP-TIM, 2M AIS, 2M LOF, 2M RDI
- SONET: LOS, LOF, AIS-S, RDI-S, TIM-P, LOP-P, AIS-P, UNEQ-P, PLM-P, RDI-P, LOM-V, LOP-V, AIS-V, UNEQ-V, PLM-V, RDI-V, RFI-V, TIM-V, DS1-AIS, DS1-LOF, 2M-AIS, 2M-LOF, 2M-RDI, 45M-AIS, 45M-LOF
- Modes: Continuous (manual), Count (0.1, 1, 10, 100 seconds)

Monitoring and Detection

- SDH: LOS, LOF, OOF, RS-TIM, MS-AIS, MS-RDI, AU-AIS, AU-LOP, HP-UNEQ, HP-PLM, HP-TIM, HP-RDI, TU-LOM, TU-AIS, TU-LOP, LP-UNEQ, LP-PLM, LP-TIM, LP-RDI, LP-RFI
- SONET: LOS, LOF, OOF, AIS-S, RDI-S, TIM-P, LOP-P, AIS-P, UNEQ-P, PLM-P, RDI-P, LOM-V, LOP-V, AIS-V, UNEQ-V, PLM-V, RDI-V, RFI-V, TIM-V

Overhead Analysis and Generation**Network Architectures supported**

- Linear (per ITU-T G.783)
- Ring (per ITU-T G.841)

Analysis – Decode and Display SOH/POH bytes in hexadecimal, binary or ASCII formats

- S1 synchronization status
- C2 HP/STS signal label
- J0 trace identifier (1, 16 or 64 bytes) in ASCII format
- J1 trace identifier (16 or 64 bytes) in ASCII format
- J2 trace identifier (16 or 64 bytes) in ASCII format
- K1, K2 APS Control
- V5 LP/VT signal label

Generation - Programmable Bytes RSOH/Section

- J0 trace: 1 byte hexadecimal, 16 byte ASCII with CRC-7 and 64 byte with CR+LF

MSOH/Line

- K1, K2 APS bytes per ITU-T G.783 and G.841
- S1 synchronization status message

HO-POH (VC-4, VC-3)/STS-POH (STS-N SPE, STS-1 SPE)

- J1 trace: 16 byte ASCII with CRC-7 or 64 byte ASCII sequence
- C2 signal label
- H4 Sequence/Multiframe Indicator
- G1 (bit 5): End-to-end path status (RDI generation)
- K3 (bits 1-4) APS signaling

LO-POH (VC-3)/STS-POH (STS-1 SPE)

- J1 trace: 16 byte ASCII with CRC-7 or 64 byte ASCII sequence
- C2 signal label
- G1 (bit 5): End-to-end path status (RDI generation)
- K3 (bits 1-4) APS signaling

LO-POH (VC-12, VC-11)/VT-POH (VT-1.5, VT-2)

- V5 (bits 5-7) LP/VT signal label
- J2 trace: 16 byte ASCII with CRC-7 or 64 byte ASCII sequence
- K4 (bits 3-4) LP/VT APS signaling

Tributary Scan

Automatically scans VC-12, VC-11, VT-1.5 or VT-2 for errors, alarms and events using a sequential BER tests

Pointer Analysis and G.783 Test Sequences

Pointer movements monitoring and generation for SDH and SONET Monitor

- AU, TU, STS and VT pointer adjustments
- SS bits, LOP, New Data Flags (NDF)
- Current value, increments, decrements, sum, difference
- Tributary frequency offset (ppm of AU/TU or STS/VT)

Generation

- Pointer sequences : ITU-T G.783, Telcordia GR-253
- Pointer Types: AU, TU, STS, VT
- Single pointer, increment, decrement, or increment/decrement
- Sequence: Basic, Single Alternating, Regular Additive, Regular Cancel, Double Alternating, Burst, Transient Burst, 87/3, 87/3 Additive, 87/3 Cancel, Periodic Additive, Periodic Cancel
- Programming of SS bits
- Adjustments: Increment, Decrement, New Value
- Parameters: N, T1, T2, T3, T4

Tandem Connection Monitoring (TCM)

Generation and analysis of N1 (HP-TCM) and N2 (LP-TCM) bytes
Detection, display and analysis of events

- UNEQ, TC-AIS, TC-ODI, TC-IEC, TC-REI, TC-OEI, TC-LTC, TC-RDI

PDH/DSn Functions

While telecommunications network technologies have evolved to include long-distance high-capacity OTN and SDH/SONET trunks, PDH/DSn links and clients are frequently retained for voice, access, service delivery and other economic reasons. As such, testing PDH/DSn interfaces, payloads and services continue to play an important role in test and measurement.

This test set provides PDH/DSn interfaces, payload generation, access and testing capabilities for 140 Mbps (E4), 45 Mbps (DS3), 34 Mbps (E3), 2 Mbps (E1), 1.544 Mbps (DS1), down to N×64 and N×56 kbps. PDH/DSn clients can be multiplexed into a higher PDH/DSn signal, mapped into SDH/SONET containers, and then mapped into OTN, giving it the flexibility to address complex test scenarios.

PDH/DSn Interfaces

Electrical

- RJ-48 (120Ω) or Bantam (100Ω) balanced
 - DS1, 1.544 Mbps, AMI & B8ZS, 100Ω balanced
 - E1, 2.048 Mbps, HDB3 & AMI, 120Ω balanced
- BNC (75Ω unbalanced)
 - E1, 2.048 Mbps, HDB3 & AMI
 - E2, 8.448 Mbps, HDB3
 - E3, 34.368 Mbps, HDB3
 - DS3, 44.736 Mbps, B3ZS
 - E4, 139.264 Mbps, CMI

Compliant to ITU-T G.703, G.823, G.824, G.772 and ANSI T1.102

Receiver Sensitivity

- 1.544 Mbps (DS1)
 - Terminate: ≤ 26 dB (cable loss only) at 0 dB DSX Tx
 - Monitor (PMP): ≤ 26 dB (20 dB resistive, 6 dB cable loss)
 - Bridge: ≤ 6 dB (cable loss only)
 - Line Equalizer function provides increased dynamic range to support for LBO < -7.5 dB

2.048 Mbps (E1)

- Terminate: ≤ 6 dB (cable loss only)
- Monitor (PMP): ≤ 26 dB (20 dB resistive, 6 dB cable loss)
- Bridge: ≤ 6 dB (cable loss only)
- Line Equalizer function provides increased dynamic range to support for LBO < -7.5 dB

8.448 Mbps (E2)

- Terminate: ≤ 6 dB (cable loss only)
- Monitor (PMP): ≤ 26 dB (20 dB resistive, 6 dB cable loss)

34.368 Mbps (E3)

- Terminate: ≤ 12 dB (cable loss only)
- Monitor (PMP): ≤ 26 dB (20 dB resistive, 6 dB cable loss)

44.736 Mbps (DS3)

- Terminate: ≤ 10 dB (cable loss only)
- Monitor (PMP): ≤ 26 dB (20 dB resistive, 6 dB cable loss)

139.264 Mbps (E4)

- Terminate: ≤ 12 dB (coaxial cable loss only)

Operating Modes

Terminate, Monitor, Bridge (E1 & DS1)

Signal Structure

1.544 Mbps (DS1)

- Unframed or Framed SF (D4), ESF per ANSI/Telcordia standards
- Fractional test signal in N x 64 kbps or N x 56 kbps, where N=1 to 24

2.048 Mbps (E1)

- Unframed or Framed with/without CRC per ITU-T G.704 (PCM30, PCM30C, PCM31, PCM31C)
- Fractional test signal in N x 64 kbps, where N=1 to 30/31

8.448 Mbps (E2)

- Unframed or Framed according to ITU-T G.742

34.368 Mbps (E3)

- Unframed or Framed according to ITU-T G.751

44.736 Mbps (DS3)

- Unframed or Framed M13 & C-Bit Parity per ITU-T G.752/G.704

139.264 Mbps (E4)

- Unframed or Framed per ITU-T G.751

Test Patterns

The following test patterns can be generated

- PRBS: $2^{31}-1$, $2^{23}-1$, $2^{20}-1$, $2^{15}-1$, $2^{11}-1$, 2^9-1 , 2^7-1 , QRSS
- Fixed: 0000, 1111, 1010, 1100, 1in8, 2in8, 3in24, DALY, NET55 and OCT55
- User defined: Ten 32-bit and one 24-Bit Programmable sequences
- Mode: Normal or Inverted

Errors

Insertion

- 1.544 Mbps (DS1): Code, FAS, Bit, Frame, CRC
- 2.048 Mbps (E1): Code, FAS, CRC, EBIT, Bit errors
- 8.448 Mbps (E2): Code, 8M FAS, 2M FAS, 2M CRC, 2M RDI, Bit errors
- 34.368 Mbps (E3): Code, 34M FAS, 8M FAS, 2M FAS, 2M CRC, 2M RDI, Bit errors
- 44.736 Mbps (DS3): Code, FAS, MFAS, P/C-Parity, Bit errors
- 139.264 Mbps (E4): Code, FAS, Bit errors
- Modes: Single, Count (# of errors), Fixed Rates (1E-9 to 1E-3)

Measurement

- 1.544 Mbps (DS1): Code, FAS, Bit, Frame, CRC
- 2.048 Mbps (E1): Code, FAS, CRC, EBIT and Bit errors
- 8.448 Mbps (E2): Code, FAS, Bit errors
- 34.368 Mbps (E3): Code, FAS, Bit errors
- 44.736 Mbps (DS3): Code, FAS, MFAS, P/C-Parity, Bit errors
- 139.264 Mbps (E4): FAS

Alarms

Generation

- 1.544 Mbps (DS1): AIS, yellow, idle, LOS, LOF
- 2.048 Mbps (E1): LOS, AIS, LOF, RDI
- 8.448 Mbps (E2): 8M AIS, 8M LOF, 8M RDI, 2M AIS, 2M LOF, 2M RDI
- 34.368 Mbps (E3): 34M LOS, 34M AIS, 34M LOF, 34M RDI, 8M AIS, 8M LOF, 8M RDI, 2M AIS, 2M LOF, 2M RDI
- 44.736 Mbps (DS3): LOS, LOF, OOF, AIS, Parity
- 139.264 Mbps (E4): LOS, AIS, LOF, RDI

Measurement

- 1.544 Mbps (DS1): AIS, yellow, idle, LOS, LOF, LSS
- 2.048 Mbps (E1): LOS, AIS, LOF, LOMF, RDI, and LSS
- 8.448 Mbps (E2): LOS, AIS, LOF, RDI, and LSS
- 34.368 Mbps (E3): LOS, AIS, LOF, RDI, and LSS
- 44.736 Mbps (DS3): LOS, LOF, OOF, AIS, Parity, LSS
- 139.264 Mbps (E4): LOS, AIS, LOF, RDI
- Modes: Continuous (manual), Count (0.1, 1, 10, 100 seconds)

Measurement Functions

Test Results

Error count, ES, %ES, SES, %SES, UAS, %UAS, EFS, %EFS, AS, %AS, and rate for all events: errors, alarms and pointer events

Performance Analysis

Measurements according to:

- ITU-T G.821: ES, EFS, SES and UAS with HRP 1% to 100%
- ITU-T G.826: EB, BBE, ES, EFS, SES, UAS; HRP of 1% to 100%
- In Service Measurement (ISM) using B1, B2, B3, FAS, CRC or Code (E1)
- Out of Service measurement (OOS) using bit errors (Test Sequence Error)
- ITU-T G.828: ES, EFS, SES, BBE, SEP, UAS with HRP 1% to 100%
- ITU-T G.829: ES, EFS, SES, BBE, UAS on RSOH (B1), MSOH (B2) or TSE
- ITU-T M.2100: ES, EFS, SES, UAS with HRP 1% to 100%
- User defined thresholds for Maintenance (MTCE) and Bringing into Service (BIS) objectives
- ITU-T M.2101: ES, EFS, SES, BBE, SEP, UAS with HRP 1% to 100%
- User defined thresholds for Maintenance (MTCE) and Bringing into Service (BIS) objectives. In service measurements on both near and far ends of path using TSE, HP-BIP/P-BIP (B3), MS-BIP/L-BIP (B2), RS-BIP/S-BIP (B1) and LP-BIP/V-BIP (V5)

Pulse Mask Analysis

PDH

- Bit rates: 2.048 Mbps (E1) and 34.368 Mbps (E3)
- Conformance Mask: ITU-T G.703

DSn

- Bit rates: 1.544 Mbps (DS1) and 44.736 Mbps (DS3)
- Conformance Masks: ITU-T G.703, ANSI T1.102, T1.403, T1.404

Mode: Non-Intrusive

Display: Pulse shape graph with Conformance mask verification (Pass/Fail)

Parameters: Width, Rise/Fall time, Overshoot/Undershoot

E1/DS1 VF Measurements Option

Codec: μ -Law or A-Law

Programmable ABCD

- Manual edit AB, ABCD or ON-HOOK, OFF-HOOK, WINK for DS1, and IDLE, SEIZE for E1

Independent Time Slot channel selection for TX and RX

- E1 channel: 1 -15, 17-31, 1 to 31
- DS1 channel: 1 to 24

Voice (Talk)

- VF drop/insert via headset
- 2.5 mm TRS audio jack for headset
- Listen to the audio channel in selected timeslot

Tone Generation and Measurement

- Transmit Frequency: 50 to 3950 Hz
- Transmit Level: -60 to 3 dBm

Results

- AB/ABCD bits monitor
- View Received Data in selected T/S
- Measure signal frequency and level in selected timeslot

DSn Functions*

DS1 and DS3 Auto-Monitor

Quickly auto-configures to the received signal and runs a health check

Provides a summary screen with all alarm indications, frequency, signal level, BPV/code errors, FBE, clock slips

Histogram and bar graph representation of errors and alarms

Channelized DS3 support with selectable DS1 channel status

DS1 Loopback Commands

In-band: CSU, NIU FAC1, NIU FC2 ESF Facility Data Link (FDL) Control Line and payload HDSL Abbreviated (short)

- From Network (CO) or CPE
- NLOC, NDU1, NDU2, NREM

HDSL Long (In-band)

- From Network (CO) or CPE
- 2-wire and 4-wire
- HTU-C, H4R1, H4R2, H4R3, HTU-R
- Arm, Query Loop, Time-out override, Loopback Query, Loop Up, Loops down, Disarm commands
- Detailed confirmation messages

User Defined codes

- Programmable codes up to 16 bits
- Programmable time out

DS1 Multi-BERT™

Sequential BER testing with up to eight test patterns

Any standard test pattern can be used, in any order

Individual pattern timing up to 3599 seconds (1 hour)

Bit, Code, FBE, ES, and total test time per pattern

Monitors signal frequency, level (dB and dBm), and total CRC count

**These features are only available in the USA user interface mode*

ISDN PRI Testing

TE and NT Emulation

Place/Receive voice and data calls

D-channel monitor with full decode: Layer 2 (Q.921) and Layer 3 (Q.931) 23B+D, 30B+D

Protocols

- DS1: National ISDN, AT&T, Nortel DMS
- E1: ETSI (Euro – ISDN)
- Bidirectional protocol capture and decode

Voice calls talk and listen via headset

In-band DTMF generation

Supports multi-rate N x 64k data calls

Parallel and sequential multi-call channel test

- All calls to a single number
- Multiple numbers from a programmable list

Supplementary Services Test

Automatically tests the provisioning of CLIP, CLIR, COLP, CFU, CFB, CFNR, SUB, MSN, DDI, HOLD, UUS, TP, AOC-S, AOCD, AOCE, MCID, CUG

Common Functions & Measurements

Service Disruption and APS Testing

Service disruption time (SDT) measurements are integrated to the regular BER tests, supporting multi-layer sensor monitoring for OTN, SDH/SONET and PDH/DSn

OTN Sensors

- LOS, OTU-AIS
- OTU-LOF, OTU-LOM, OTU-IAE, OTU-BDI, SM-BIAE, ODU-AIS, ODU-LCK, ODU-OCI
- FAS, MFAS, OTU-BIP, OTU-BEI, ODU-BIP, ODU-BEI

SDH Sensors

- LOS, LOF, FAS
- B1, MS-AIS, MS-RDI, MS-REI, B2, AU-AIS, AU-LOP, B3, HP-RDI, HP-REI, TU-AIS
- PDH payload-related triggers
- LSS

SONET Sensors

- LOS, LOF, FAS
- S-BIP, AIS-L, RDI-L, REI-L, L-BIP, AIS-P, LOP-P, P-BIP, RDI-P, REI-P, AIS-V
- PDH payload-related triggers
- LSS

PDH (E1) Sensors

- E1-LOF, E1-AIS
- LSS

Pass/Fail range: 15 to 200 ms

Gate Time: 20 to 4000 ms

SDT Results Summary

- Last Service Disruption Time
- Longest Service Disruption Time
- Shortest Service Disruption Time
- Time stamps
- Resolution: 10 μ s
- Total number of Service Disruptions events observed

Disruption Events Table

- Tracks every Service Disruption event for all layers
- Time stamp with 10 μ s resolution
- Duration with 10 μ s resolution
- Individual Pass/Fail Verdicts
- Tracks individual sensor events that occurred during the disruption period with time stamp and duration (10 μ s resolution)

APS Testing

- SDH/SONET APS Byte (K1/K2) sequence capture and decode

Auto Configuration

Available for SDH, PDH, SONET and DSn signals

Identification of received signal - instrument configuration based on network type, bit rate, line coding, framing, mapping, and test pattern

Signal Level and Frequency Measurement

Available for Optical and Electrical Interfaces

Signal level

Optical power in dBm and Loss/Saturation graph

Electrical level in Volts peak-to-peak, dB and dBm

Frequency (Line and Payloads)

Resolution: 1 bit/s (bps)

Frequency Offset

Resolution: 0.1 ppm Current, Minimum and Maximum

Clock Slips (E1 and DS1)

Round Trip Delay

(Available for all interfaces & mappings)

Measurement Range: 1 μ s to 10 seconds

Resolution: ± 1 μ s or 1 U.I.

Event Logging

Date and time stamped records of all error and alarm events occurred during a test, presented in tabular format

Histograms

(Available for all interfaces)

Histogram: Simultaneous display of Errors and Alarms versus time for sequence of events correlation

Bar Graph: Individual Error or Alarm severity versus time

Resolution: Seconds, minutes, hours and days

Soft LED Indicators

Summary indicators for Signal, Framing, Pattern sync and Errors/Alarms

Display historical events and conditions

History reset function

- Clears the LED reminder without affecting the measurement counters

Jitter/Wander Analysis Options

Complete Jitter Test Suite

- Output Jitter measurement
- Jitter generation (1 Hz to 40 kHz)
- Maximum Jitter Tolerance test
- Jitter Transfer Function test

Graphical and tabular results

Fully compliant to ITU-T O.171 and O.172

Jitter Measurements

HP1+LP (Wide-band Jitter) filter

- E1 (2M) 20 Hz to 100 kHz
- E3 (34M) 100 Hz to 800 kHz
- DS1 (1.5M) 10 Hz to 40 kHz
- DS3 (45M) 10 Hz to 400 kHz
- STM-1/OC-3 (155M Optical) 500 Hz to 1.3 MHz

HP2+LP (High-band Jitter) filter

- E1 (2M) 18 Hz to 100 kHz
- E3 (34M) 10 Hz to 800 kHz
- DS1 (1.5M) 18 Hz to 100 kHz
- DS3 (45M) 30 Hz to 400 kHz
- STM-1/OC-3 (155M Optical) 65 Hz to 1.3 MHz

Parameters: Current peak-peak, Maximum peak-peak

Color-coded Pass/Fail indication according to ITU-T limits

Standard Pass/Fail masks

Units: UI (Unit Interval)

Resolution: 0.01 UI

Accuracy: Per ITU-T O.171 and O.172

Graphical display of Jitter behavior over time

Test Duration: Continuous

Jitter Generation

Frequency: 1 Hz to 1.3 MHz

Amplitude: 0.01 to 50 U_{lpp}

Resolution: 1 Hz, 0.01 UI

Wander Measurements

Fully compliant to ITU-T O.171 and O.172

Test Interfaces: E1 (2M), E3 (34M), DS1 (1.5M), DS3 (45M), and STM-1 (155M Optical)

Reference Clocks

- Port: SMA
- Sources: 2.048 Mbps, 1.544 Mbps, 2.048 MHz or 1.544 MHz, System 1PPS (GPS and/or Atomic Clock)

Parameters

- Real Time Measurements
- Time Interval Error (TIE), Maximum TIE (MTIE) per O.171

MTIE/TDEV Wander Data Logging Option

Saves long-term real-time TIE samples directly to a USB memory for further MTIE and TDEV post-analysis, using VeEX's Wander Analysis PC software

Sample rates: 1, 5, 10, 30 samples/s

Resolution: Down to 7 ns

MTIE & TDEV Pass/Fail Analysis

- Standard masks included
- User-defined masks

TIE, MTIE and TDEV comparisons

Report Generation

Ethernet/Fibre Channel Interfaces

Ethernet Electrical

10/100/1000Base-T Port: RJ45 connector

Ethernet Classification: Per IEEE 802.3

Ethernet Optical

SFP optical port supporting 100BaseFX/ 1000BaseX

XFP optical port supporting 10GE (LAN/WAN PHY)

Support for tunable XFP

Clock offset +/- 150 ppm

1/2/4G SFP*

100Base-FX/1000Base-X SFP Ports: LC connector

1/2/4G Fiber Channel SFP Port: LC connector

SFP transceivers per Multi Source Agreement (MSA)

ROHS compliant and Lead Free per Directive 2002/95/EC

Operating temperature range: -10°C to 70°C

Eye Safety: Class 1, per FDA/CDRH, EN (IEC) 60825

Power Measurement: ± 2 dB accuracy, 1 dB resolution

Operating temperature range: -10°C to 70°C

Eye Safety: Class 1, per FDA/CDRH, EN (IEC) 60825

Power Measurement: ± 2 dB accuracy, 1 dB resolution

8/10G XFP*

8/10G FC XFP Port, 10GE LAN and 10GE WAN PHY, LC connector

XFP transceivers per Multi Source Agreement (MSA)

ROHS compliant and Lead Free per Directive 2002/95/EC

Operating temperature range: -10°C to 70°C

Eye Safety: Class 1, per FDA/CDRH, EN (IEC) 60825

Power Measurement: ± 2 dB accuracy, 1 dB resolution

**Ethernet and Fibre Channel share SFP and XFP ports*

***Data rates, performance, and supported transmission protocols are only guaranteed for SFPs and XFPs supplied by VeEX Inc. If selecting or using other vendors, users should exercise caution*

Ethernet

Modes of Operation

Terminate
Loopback

Traffic Generation

Layer 1 Unframed (optical port only)/Framed, Layer 2, Layer 3, Layer 4
Test Frame Header

- IEEE 802.3 and Ethernet II (DIX) frames
- Configurable Source and Destination MAC and Ethernet Type
- VLAN stacking up to 3 Q-in-Q tags w/configurable priority & type
- Fully configurable IPv4 or IPv6 header
- MPLS up to 3 labels with configurable Label/S/CoS and TTL fields
- MPLS-TP label with configurable LSP, PW and CW fields
- UDP/TCP header with configurable Source & Destination ports
- Provider Backbone Bridge (PBB) support with configurable Backbone MAC Source and Destination, I-SID, PBB-VLAN ID and priority

1GE Fixed or Uniform distribution frame size from 64 to 10000 bytes (Layer 4 tests Fixed frame size up to 1518 only, 10GE Fixed, Random and Increment/Decrement frame size distribution from 64 to 10000 bytes)

Traffic Pattern: Constant, Ramp, Multi Bursts, Single Burst

1GE Error Injection: Single and Count; Symbol (Layer 1 Unframed, 1GE only), Bit, CRC, Pause, IP Checksum, TCP/UDP Checksum

10GE Error Injection: Single, Count and Rate; Bit, CRC, Sync Header Error, Block Type Error, Pause, IP Checksum, TCP/UDP Checksum

Alarm Injection: Count (duration) or Continuous

- 10GE LAN: Local Fault, Remote Fault, PCS-HI-BER, PCS-LOBL,
- 10GE WAN SONET: Local Fault, Remote Fault, LOF, AIS-L, RDI-L
- 10GE WAN SDH: Local Fault, Remote Fault, LOF, MS-AIS, MS-RDI

Bit Error Rate Test

Test Patterns

- 1GE and 10 GE PRBS: $2^{31}-1$, $2^{23}-1$, $2^{15}-1$, $2^{11}-1$, normal and inverted patterns, All 0s, All 1s and User Defined (Layer 2,3,4)
- 1GE: HFPAT, LFPAT, MFPAT CRPAT, RDPAT, JTPAT, SNPAT (Layer 1 Unframed) CRPAT, CJPAT, CSPAT (Layer 1 Framed)
- 10GE: PRBS, LAN Seed A and B (Layer 1 Unframed), CRPAT and CJPAT (Layer 1 Framed)

Error Measurements: Bit/BER, Symbol (Layer 1 Unframed), FCS/CRC, Jabber/Runt frames, IP Checksum, TCP/UDP Checksum

Alarm Detection

- 10GE: LOS, LOSync, PAT Loss, Service disruption (current, total, last, min/max, # of occurrences), Local Fault, Remote Fault, PCS-HI-BER, PCS-LOBL, WAN SONET Alarms: LOF, AIS-L and RDI-L WAN SDH Alarms: LOF, MS-AIS, MS-RDI
- 1GE: LOS, LOSync, PAT Loss, Service disruption (current, total, last, min/max, # of occurrences)

Frame/Packet Statistics

- Multicast, broadcast, unicast, pause frames, frame size distribution
- Rates (min, max, average and current): frame rate, bandwidth utilization, frame rate, line rate, data rate
- Frame arrival time (min, max, average and current), Frame Delay Variation

Multiple Streams Throughput Testing

Up to 8 independent traffic streams generation and analysis, with configurable filters on 1GE interface

Up to 10 independent traffic streams generation and analysis, with configurable filters on 10GE interface

Each stream can be set with independent frame size, bandwidth, traffic profile, and QoS levels

MAC flooding feature: generates test frames with up to 4096 incrementing Source and/or Destination MAC addresses

VLAN flooding feature: generates test frames with up to 4096 incrementing VLAN IDs

Test Patterns: PRBS: $2^{31}-1$, $2^{23}-1$, $2^{15}-1$, $2^{11}-1$, normal and inverted patterns, All 0s, All 1s and User Defined

Error Measurements: Bit/BER (Single Stream only), FCS/CRC, Jabber/Runt frames, IP Checksum, TCP/UDP Checksum, Frame Loss (count and %), Out of Sequence

Alarm Detection

- 10GE: LOS, LOSync, Service disruption (current, total, last, min/max, # of occurrences), Local Fault, Remote Fault, PCS-HI-BER, PCS-LOBL, WAN SONET Alarms: LOF, AIS-L and RDI-L WAN SDH Alarms: LOF, MS-AIS, MS-RDI
- 1GE: LOS, LOSync, Service disruption (current, total, last, min/max, # of occurrences)

Frame/Packet Statistics

- Multicast, broadcast, unicast, pause frames, frame size distribution
- Rates (min, max, average and current): frame rate, bandwidth utilization, frame rate, line rate, data rate
- Frame arrival time (min, max, average and current), Frame Delay Variation
- Round Trip delay or one-way delay* (min, max, average and current) and Histogram distribution with configurable sampling period and threshold

* Requires GPS option

RFC2544 Compliance Testing

Automated tests compliant with RFC2544 with configurable threshold values and maximum transmit bandwidth settings

Throughput, Latency, Frame Loss, and Back-to-Back (burst) tests

Frame sizes: 64, 128, 256, 512, 1024, 1280, 1518 bytes and 2 user configurable frames

Tests can be done to a remote loopback or in Peer to Peer mode to a remote test set configured as a responder

Peer to peer mode allows asymmetric bandwidth RFC2544 test

RFC2544 Advanced SLA Mode

RFC2544 compliant test on primary test stream with up to 7 independent background traffic streams

Each background stream can be set with independent frame size, bandwidth, traffic profile, and QoS levels

ITU-T Y.1564 V-SAM Test

V-SAM test suite compliant with ITU-T Y.1564 standard
 Support for Multi-stream traffic generation, Service Configuration and Service Performance tests
 Independently configurable for each stream

- Frame size: Fixed or EMIX pattern (1GE only)
- Bandwidth profile parameters: CIR, EIR, CBS (1GE only), EBS (1GE only) Traffic Policing
- Service acceptance criteria: FLR, FTD, IFDV, AVAIL

Simple summary Pass/Fail results tables and drill down capability with detailed measurements (Frame Loss, Frame Transfer Delay, Frame Delay Variation, Availability) for each service

Link Level OAM - IEEE 802.3ah

Modes: Active and Passive, with configurable Vendor OUI, Vendor SPI, MAX PDU length, and PDU rate

Discovery capabilities: remote loopback, link events, MIB retrieval

Link Events Notifications: Link Fault, Critical Event, Dying Gasp

Remote Loopback control

Service Level OAM-IEEE 802.1ag, ITU-T Y.1731 and MPLS-TP OAM ITU-T G.8113.1

MEP emulation with configurable MD name, MA name, local MEP ID, MD level, VLAN ID

ITU-T G.8113.1 configurable LSP and PW label, CoS, TTL, GAL Label 13 or 14, CoS, TTL, ACH Channel Type

Continuity Check Message (CCM): with priority level & interval selection

Loopback Messages (LBM/LBR): loopback message generation and response to destination MEP or MAC address

Link Trace Messages (LTM/LTR): link trace message generation and response to destination MEP or MA address with configurable TTL

Loss Measurement Messages (LMM/LMR): loss measurement message generation and response to destination MEP or MAC with configurable rate and number of messages

Delay Measurement Messages (DMM/DMR): delay measurement message generation and response to destination MEP or MAC with configurable rate and number of messages

Smart Loopback Mode

Layer 1: incoming traffic looped back unchanged

Layer 2: incoming traffic looped back with MAC source and destination addresses swapped

Layer 3: incoming traffic looped back with MAC and IP source and destination addresses swapped

Layer 4: incoming traffic looped with MAC, IP, and UDP/TCP ports swapped

Configurable traffic filters on MAC and IP source and destination addresses, VLAN ID and Priority, IP Precedence and TOS, UDP source and destination ports

All key measurements on received traffic provided on loopback unit

VePAL Discovery Function and Remote Control

Discovery function to all VeEX VePAL devices within subnet or manual control of VeEX VePAL devices in routed network

Remote Control of Loopback capability

Peer to Peer Controller/Responder configuration for RFC2544 test with asymmetric bandwidth test capability for end-to-end RFC2544 test

VLAN Scan and Monitor

Scans incoming traffic and discovers all VLAN flows including Q-in-Q tagging

Key statistics on traffic rates, alarms and errors are reported for monitored streams (up to 8)

IPv6

IPv6 compliant test traffic generation and analysis for all test applications (Y.1564 V-SAM, RFC2544, BERT and Multi-stream Throughput)

IPv6 Loopback capability

IPv6 Static or Stateless Auto Configuration, Ping and Trace Route functions

Layer 4-7 Features**V-Perf Test**

TCP Throughput Compliant with RFC6349

Stateful TCP Test at line rate

TCP Client and Server modes

Compatible with iPerf Client/Server

MTU search per RFC4821

Round Trip Time Measurement

Configurable TCP Window sizes

Multi-Window size tests

Measurements: TCP Throughput rate (min, max, average), Transfer file size and duration, Transfer time ratio, TCP Efficiency %, Buffer Delay %

Ve-Test HTTP Test

HTTP Throughput

Full line rate

HTTP client mode

Connection time to server

Total Data Transfer time

HTTP Throughput rates

Requires VeTest Server

FTP Throughput Test

FTP Throughput

Full line rate

FTP client mode

Connection time to server

Total Data Transfer time

FTP Throughput rates

Compatible with Linux and Windows FTP servers

Packet Network Synchronization

Modes of Operation

Master clock emulation: Offers recovered clock output (clock translation) for external analysis or to provide timing to other devices

Slave clock emulation: Offers recovered clock output (clock translation) for external analysis or to provide timing to other devices

ITU-T G.8261/SyncE

Master/Slave clock emulation

- ESMC SSM generation: configurable message type and rate

Measurements

- ESMC SSM messages counters
- ESMC SSM messages display and decode
- ESMC SSM messages capture in pcap format

IEEE 1588v2/PTP

Master clock emulation

- Unicast and multicast master emulation
- IPv4 and IPv6 support
- 2-step clock
- Configurable announce, Sync and Delay_req rates and domain number

Slave clock emulation

- Unicast or multicast slave emulation
- IPv4 and IPv6 support
- 1-step or 2-step clock
- Configurable announce, Sync and Delay_req rates and domain number

Measurements

- Message counters (Sync, Follow up, Delay Request/Response, Pdelay Request/Response, signaling, management) and statistics (Loss, CRC error, duplicate, out of order)
- PTP messages display and decode
- PTP messages capture in pcap format
- PDV measurements and graph display (Sync PDV, Delay_Req PDV)
- Round trip delay measurements and graph display
- IPG measurements and graph display

Clock Input and Output

Reference Clock (Master Emulation and Wander/Phase Measurements)

- Internal, GPS 1PPS (Raw), Atomic 1PPS, Atomic 10 MHz
- External: 1PPS, 1.544 Mbps, 1.544 MHz, 2.048 Mbps, 2.048 MHz, 10 MHz, 25 MHz, 125 MHz

Recovered Clock Output (Clock Translation)

- 1PPS, 2.048 Mbps, 2.048 MHz, 10 MHz, 25 MHz, 125 MHz

Wander Measurements

Measures wander on SyncE or 1588v2 slave recovered clock signal Parameters

- Time Interval Error (TIE), Minimum TIE, Maximum TIE and MTIE
- Absolute Phase (Timing) Error Measurement (TE)
- Saves long-term real-time TIE samples directly to a USB memory for further MTIE and TDEV post-analysis, using VeEX's Wander Analysis PC software
- Built-in MTIE/TDEV Wander Analysis

Network Troubleshooting Tools

Packet Capture

Line rate Packet capture from test interfaces

- 10/100/1000BaseT
- 100FX/1000BaseX
- 10GE

Configurable capture filters

- MAC and IP
- UDP and/or TCP
- Multicast, Broadcast, IP Checksum error, UDP/TCP Checksum Error events

Integrated Wireshark™ packet decode

Packet captures can be saved and exported PCAP capture format, compatible with Wireshark

Fibre Channel

Fibre Channel Rates

1.0625 Gbps, 2.125 Gbps, 4.25 Gbps, 8.5 Gbps, and 10.52 Gbps

Modes of Operation

Terminate, Loopback

Fibre Channel Topology

Point-to-Point

Primitive Sequence Protocols

Link initialization, link rest, link failure

Flow Control

Buffer-to-Buffer Credit Configuration: 1-65535

Traffic Generation

FC-1 (with SOF and EOF frame delimiters) and FC-2 Frames

Class 3 Service frames

Scrambling/Descrambling (8.5 Gbps only)

Configurable Header fields

Configurable EOF (EOF_t, EOF_n), and SOF (SOF_i3, SOF_n3, SOF_f)

Traffic Shaping: constant, ramp, burst

Frame Length Configuration: 2148 bytes maximum

RFC2544 Compliance Testing

Automated tests compliant with RFC2544 with configurable threshold values for Throughput and Round Trip Delay (Latency) and maximum transmit bandwidth settings

Throughput, Latency, Frame Loss, and Back-to-Back (burst) tests

Frame sizes: 64, 128, 256, 512, 1024, 1280, and 2000 bytes including 2 user configurable frames

Bit Error Rate Testing

NCITS-TR-25-1999 Patterns (FC-1): CRPAT, CSPAT, CJTPA

PRBS Patterns (FC-2): 2³¹-1, 2²³-1, 2¹⁵-1, 2¹¹-1, normal and inverted selections, and user defined patterns

Error Injection: Bit and CRC

Loopback Mode

FC-1

FC-2 (Layer 2): swaps the destination and source IDs (D-ID and S_ID)

Key Measurements

Optical power levels: transmit and receive optical levels in dBm

Error Measurements: Bit error count, BER, symbol, FCS/CRC, oversize, undersize, frame loss (count and %), out of sequence frame count

Alarm Detection: LOS, pattern loss, service disruption

Traffic Statistics: bandwidth utilization, data rate, frame count, byte count, frame size distribution, buffer-to-buffer credit count, RR_RDY count, frame loss count and round trip delay

Rates: line rate, framed rate, data rate, frames per second rate

Delay (min, max, avg, current): round trip delay, frame arrival delay

CPRI/OBSAI Testing

614.4 Mbps, 1.2288 Gbps, 2.4576 Gbps, 3.072 Gbps, 4.9152 Gbps, 6.144 Gbps, 9.8304 Gbps interface per CPRI (Common Public Radio Interface) standard

768 Mbps, 1.536 Gbps, 3.072 Gbps, 4.9152 Gbps, 6.144 Gbps per OBSAI (Open Base Station Architecture Initiative) standard

Unframed BER (CPRI, OBSAI), Layer 1 Framed and Layer 2 (CPRI) BER Test with PRBS stress test pattern

CPRI Layer 2:

Error Injection: Bit, Code Violation

Alarm Injection: LOS, LOF, SDI, RAI, RLOS, RLOF

Error measurements: Bit, BER, CV, CV Rate, Pattern Loss

Alarms detection: LOS, LOF, HLOF, HLOF, BLOF, SDI, RAI, RLOS, RLOF

Latency measurement

Service Disruption Test

Frequency and Offset (current, min, max)

TX/RX Hyperframes and NodeB Frames counters

Configurable HDLC and Ethernet C&M channels

Control Words decode

CPRI Hyperframes capture

Precision Timing References

The RXT-3000 Combo offers two highly accurate and stable clock reference options to provide precise timing to all its test modules. The physical clock can be used as a reference for frequency and wander measurements and the UTC time of day (ToD) can be used for time-sensitive tests like one-way-delay measurements.

Disciplining and holdover: Combining the accuracy of the GPS option, the stability of the Atomic clock option and its battery operation, the RXT-3000 Combo can offer precision clock reference even in places where GPS is not available or can't be trusted (e.g. in-building or urban canyon applications).

GPS Option

The optional high-sensitivity GPS module (built-in) provides precise UTC synchronization to the RXT-3000 Combo, in the form of internal 1PPS clock synchronized to the coordinated second and time stamps.

Frequency: L1, 1575.42 MHz

Channels: 20

Sensitivity

- Cold start: -144 dBm
- Tracking: -159 dBm

Clock Output: 1PPS (internal)

Accuracy

- Time: 50 ns RMS
- Position: 5m

Acquisition Time

- Cold start: 35s
- Hot start: 1s

Recommended Antenna

- Type: Active
- Gain: >15 dBi
- Noise: <1.5 dB
- Connector: SMA, 50 Ohms
- Power: 3.3 Vdc, 30 mA

Temperature range: 0 to 45°C

Atomic Clock Option

The optional built-in chip-scale Atomic Clock module provides a highly stable clock source to the RXT-3000 Combo, in the form of internal 1PPS or 10 MHz signals. The Atomic Clock can also be disciplined by the GPS (requires GPS option) and later be used in holdover mode for extended time (e.g. temporary holdover timing or frequency reference for indoor usage).

- Accuracy: ± 50 ns
- Aging: $< 3.0E-10$ /month
- Warm-up time: <120s
- Temperature range: 0 to 45°C

Modes of Operation

- Free running or GPS-disciplined
- Programmable disciplining time constant up to 10000s
- Sleep mode: Recalibrates the atomic clock while the test set is OFF and Battery > 50% charge

Precision References (internal)

- Frequency: Atomic 10 MHz
- Phase/Time: Atomic 1PPS

VeEX MTIE/TDEV Wander Analysis PC software

- Provides further post-processing of clock stability data, such as MTIE and TDEV for long-term tests
- Frequency offset calculation and removal for relative TIE analysis
- Standard and user-programmable masks
- PDF report generation
- Fully resizable window, to accommodate any screen size and provide detailed zoom levels
- Compact stand-alone Windows(r) software. It can be carried in the same USB memory as the TIE data. No installation is necessary

Platform Features & Options

ReVeal RXTS PC Software

Companion management software for PC

Test results management

Advanced report generation with html, pdf, or csv formats, combine test results, add logos and comments

Test profiles management: Online or offline test profile creation, upload and download

Bluetooth Option***

Supports compatible USB Bluetooth™ dongle for file transfers to PC and mobile devices and to provide IP connectivity

*** Requires compatible Bluetooth USB dongle

Remote Control Option

Remote control via VNC client, web browser, ReVeal RXTS, SCPI Remote PC software*

Scripting via SCPI commands

Connectivity: 10/100Base-T, Wi-Fi 802.11 a/b/g/n*

*Not included

File Manager

Profiles: Save and recall test profiles

Saves results to internal SD card

View, Rename, Delete and Lock profile and result files

Filter and sort by Name, Test Mode, Test Type, Port, Date and Result/Profile

Report generation: Test results generation in PDF format

Export test results and profiles via USB memory, Bluetooth, web browser, Data Card or ReVeal RXTS companion PC software

File Backup and Retrieve to/from USB

Screen capture: Screen shots in .bmp format



VeEX Inc.
2827 Lakeview Court
Fremont, CA 94538 USA
Tel: +1.510.651.0500
Fax: +1.510.651.0505
www.veexinc.com
customer@veexinc.com

© 2015 VeEX Inc. All rights reserved.
VeEX is a registered trademark of VeEX Inc. The information contained in this document is accurate. However, we reserve the right to change any contents at any time without notice. We accept no responsibility for any errors or omissions. In case of discrepancy, the web version takes precedence over any printed literature.
D05-00-082P A00 2015/01